

Multichannel Calibrator PASCAL ET, ET-P, ET/IS, ET-P/IS

GB



Documenting Multivariable Multichannel Calibrator PASCAL ET, ET-P, ET/IS, ET-P/IS



# Contents

<b>1</b>	<b>General Information.....</b>	<b>5</b>
<b>2</b>	<b>Safety .....</b>	<b>6</b>
2.1	Intended use .....	7
2.2	Personnel qualification.....	7
2.3	Additional safety instructions for instruments with ATEX approval only Pascal ET/IS.....	8
2.4	Special hazards .....	9
2.5	Labelling / safety marks .....	10
<b>3</b>	<b>Specifications .....</b>	<b>11</b>
<b>4</b>	<b>Design and Function .....</b>	<b>16</b>
4.1	Description .....	16
4.2	Scope of delivery .....	17
4.3	Power supply .....	17
<b>5</b>	<b>Transport, packaging and storage .....</b>	<b>18</b>
5.1	Transport.....	18
5.2	Packaging .....	18
5.3	Storage .....	18
<b>6</b>	<b>Commissioning, operation.....</b>	<b>19</b>
6.1	Commissioning .....	19
6.1.1	Instrument overview.....	19
6.1.2	Functional Modules.....	19
6.1.2.1	Input module for electrical/temperature signals.....	20
6.1.2.2	Output module for electrical/temperature signals .....	20
6.1.2.3	Pressure module.....	21
6.1.2.4	HART module .....	21
6.1.2.5	Environmental parameters module (optional).....	24
6.2	Electrical .....	24
6.2.1	Electrical measurements.....	25
6.2.2	Thermocouple measurements .....	26
6.2.3	Thermoresistance measurements .....	27
6.2.4	Generation of electrical parameters.....	28
6.2.5	Thermocouple simulation.....	28
6.2.6	Thermoresistance simulation.....	29
6.3	User Interface .....	30
6.3.1	Channel configuration .....	32
6.3.2	Other assignments.....	38
6.3.2.1	Pressure measurement.....	38
6.3.2.2	Thermocouple signal measurement .....	41
6.3.2.3	Electrical parameter measurement.....	44
6.3.2.4	Temperature Simulation.....	46
6.3.2.5	Electrical parameter generation.....	46
6.3.2.6	Channel C or D – mathematic functions .....	47
6.3.2.7	HART channel assignment.....	51
6.3.2.8	HART trimmer calibration.....	54
6.3.2.9	HART scale adjust .....	56
6.4	Setting channel, function, instrument.....	57
6.4.1	Channel setting .....	57
6.4.2	Functions setting.....	60
6.4.3	Instrument setting .....	61
6.4.3.1	Setting the "F" key of the keyboard.....	62
6.5	Channel settings .....	63
6.5.1	Offset On – Offset Off .....	63
6.5.2	Scaling .....	64
6.5.3	Hold On – Hold Off.....	65
6.5.4	Modification of the generation/simulation value.....	65
6.6	Report .....	66
6.6.1	Report of Tc/Rtd with dry well calibrator or dry block management .....	71
6.7	Data Logger .....	77

6.8	Communication .....	78
6.9	Calibration Examples .....	79
6.9.1	Example 1 – Calibration of 2-wire pressure transmitters .....	79
6.9.2	Example 2 – Calibration of PTZ gas volume converters .....	80
6.9.3	Example 3 – Calibration of 4-wire RTD's .....	80
6.9.4	Example 4 – Calibration of Thermocouples .....	82
<b>7</b>	<b>Maintenance, cleaning and servicing .....</b>	<b>83</b>
7.1	Maintenance .....	83
7.2	Cleaning .....	83
7.3	Recalibration .....	83
<b>8</b>	<b>Dismounting, return and disposal .....</b>	<b>84</b>
8.1	Dismounting .....	84
8.2	Return .....	84
8.3	Disposal .....	84

Declarations of conformity can be found online at [www.wika.com](http://www.wika.com).

### 1 General Information

- The Multichannel Calibrator model Pascal ET, ET-P, ET/IS, ET-P/IS described in the operating instructions has been manufactured using state-of-the-art technology. All components are subject to stringent quality and environmental criteria during production. Our management systems are certified to ISO 9001 and ISO 14001.
- These operating instructions contain important information on handling the Multichannel Calibrator model Pascal ET or Pascal ET/IS. Working safely requires that all safety instructions and work instructions are observed.
- Observe the relevant local accident prevention regulations and general safety regulations for the range of use of the Multichannel Calibrator model Pascal ET or Pascal ET/IS.
- The operating instructions are part of the instrument and must be kept in the immediate vicinity of the Multichannel Calibrator model Pascal ET, ET-P, ET/IS, ET-P/IS and readily accessible to skilled personnel at any time.
- Skilled personnel must have carefully read and understood the operating instructions, prior to beginning any work.
- The manufacturer's liability is void in the case of any damage caused by using the product contrary to its intended use, non-compliance with these operating instructions, assignment of insufficiently qualified skilled personnel or unauthorized modifications to the Pascal ET or Pascal ET/IS.
- The general terms and conditions, contained in the sales documentation, shall apply.
- Subject to technical modifications.
- Factory calibrations/DKD/DAkkS calibrations are carried out in accordance with international standards.
- Further information:

## Explanation of symbols

GB



### **WARNING!**

... indicates a potentially dangerous situation, which can result in serious injury or death, if not avoided.



### **Information**

... points out useful tips, recommendations and information for efficient and trouble-free operation.



### **WARNING!**

... indicates a potentially dangerous situation in a potentially explosive atmosphere, resulting in serious injury or death, if not avoided.

## 2 Safety



### **WARNING!**

Before installation, commissioning and operation, ensure that the appropriate reference pressure sensor has been selected in terms of measuring range, design and specific measuring conditions. Serious injuries and/or damage can occur should these not be observed.



Further important safety instructions can be found in the individual chapters of these operating instructions.

## 2.1 Intended use

The Multichannel Calibrator model Pascal ET or Pascal ET IS gauge can be used as a calibration instrument and also for any application which requires accuracy pressure measurement.

The Multichannel Calibrator model Pascal ET, ET-P, ET/IS, ET-P/IS has been designed and built solely for the intended use described here, and may only be used accordingly.

The technical specifications contained in these operating instructions must be observed. Improper handling or operation of the Multichannel Calibrator model Pascal ET, ET-P, ET/IS, ET-P/IS outside of its technical specifications requires the instrument to be shut down immediately and inspected by an authorized WIKA service engineer.

Handle electronic precision measuring instruments with the required care (protect from strong magnetic fields, static electricity and extreme temperatures, do not insert any objects into the instrument or its openings). Plugs and sockets must be protected from contamination.

If the Multichannel Calibrator model Pascal ET, ET-P, ET/IS, ET-P/IS are transported from a cold into a warm environment, the formation of condensation may result in the instrument malfunctioning. Before putting it back into operation, wait for the instrument temperature and the room temperature to equalize.

The manufacturer shall not be liable for claims of any type based on operation contrary to the intended use.

## 2.2 Personnel qualification



### **WARNING!**

Risk of injury should qualification be insufficient!

Improper handling can result in considerable injury and damage to equipment.

- The activities described in these operating instructions may only be carried out by skilled personnel who have the qualifications described below.

### **Skilled personnel**

Skilled personnel are understood to be personnel who, based on their technical training, knowledge of measurement and control technology and on their experience and knowledge of country-specific regulations, current standards and directives, are capable of carrying out the work described and independently recognizing potential hazards.

Special operating conditions require further appropriate knowledge, e.g. of aggressive media.

### 2.3 Additional safety instructions for instruments with ATEX approval only Pascal ET/IS

GB



#### WARNING!

Non-observance of these instructions and their contents may result in the loss of explosion protection.

- Battery operation:  
Use only the rechargeable battery which is supplied by WIKA! Only charge the battery outside of the hazardous area!
- Operation of the serial interface in the hazardous area is prohibited.



#### Further hazardous area safety instructions!

Observe the operating information and the relevant country-specific regulations concerning use in hazardous areas (e.g. EN IEC 60079-14).

The Pascal ET/IS intrinsically safe multichannel calibrator has been designed for use in Ex Hazardous Areas. These are areas where potentially flammable or explosive vapors may occur. These areas are referred to as hazardous (classified) locations in the United States, as Hazardous Locations in Canada, as Potentially Explosive Atmospheres in Europe and as Explosive Gas Atmospheres by most of the rest of the world. The Pascal ET/IS intrinsically safe multichannel calibrator is designed as intrinsically safe. This means that connecting the Pascal ET/IS intrinsically safe multichannel calibrator to equipment that is used within intrinsically safe circuits will not cause an ignition capable arc as long as the entity parameters are suitably matched.

#### Information/Approval for hazardous locations:



#### WARNING!

##### ■ Ex Hazardous Areas

An Ex-hazardous area as used in this manual refers to an area made hazardous by the potential presence of flammable or explosive vapors. These areas are also referred to as hazardous locations.



II 2G

Ex ib IIC T4 Gb - Tamb: -10°C / 50°C



#### WARNING!

Only gauges powered by batteries are approved for use in hazardous locations. Use only the rechargeable battery which is supplied by WIKA! Only charge the battery outside of the hazardous area!



## 2.4 Special hazards



### WARNING!

- When measuring pressure, make sure that the process pressure line is shut off and depressurized before it is connected to or disconnected from the pressure module.
- Disconnect test leads before changing to another measurement or generation function.
- Observe the working conditions in accordance with chapter "3. Specifications".
- Always operate the device within its overload limits.
- To ensure problem-free operation, only operate the Multichannel Calibrator model Pascal ET, ET-P, ET/IS, ET-P/IS on battery power. Only use the mains connection for charging the Hand-held pressure calibrators batteries.
- Do not apply a voltage greater than the specified voltage to the instrument. See chapter "3. Specifications".
- Make sure that the test probes never contact a voltage source while the test leads are connected to the current terminals.
- Do not use the calibrator if it is damaged. Before using the multichannel calibrator, check that there are no cracks or missing plastic parts on the case. Pay particular attention to the insulation of the connectors.
- Select the proper function and correct measuring range for the measurement.
- Inspect the test leads for damaged insulation or exposed metal. Check the continuity of the test leads. Damaged test leads should be replaced before using the multichannel calibrator.
- When using test probes keep fingers away from the test probe contacts. Keep your fingers behind the test probes' finger guards.
- First connect the common lead, and then the live lead. When disconnecting, remove the live test lead first.
- Do not use the multichannel calibrator if it is not working properly. The instrument protection might be compromised. If in doubt, have the instrument checked.
- Do not operate the calibrator in areas with explosive gases, vapours or dust.
- To avoid false readings, which could lead to possible electric shock or personal injury, charge the rechargeable battery as soon as the battery indicator appears.
- In order to avoid any possible damage to the multichannel calibrator or the test equipment, use the correct leads, the correct function and the correct range for the measuring application.

## 2.5 Labelling / safety marks

GB

## Explanation of symbols

## Pascal ET and Pascal ET/IS



Before mounting and commissioning the Multichannel Calibrator model Pascal ET or Pascal ET/IS, ensure you read the operating instructions!

**CE, European Community**

Instruments bearing this mark comply with the relevant European directives.



This marking on the instruments indicates that they must not be disposed of in domestic waste. The disposal is carried out by return to the manufacturer or by the corresponding municipal authorities. See Directive 2002/96/EC.

## Only Pascal ET/IS

**ATEX European Explosion Protection Directive**

(Atmosphère = AT, explosible = Ex)

Instruments bearing this mark comply with the requirements of the European Directive 94/9/CE (ATEX) on explosion protection.



**IECEx** for IEC 60079-0, IEC 60079-11



## 3 Specifications

<b>Base instrument</b>	
<b>Indication</b>	
Display	Touchscreen + 5 keys
Dimensions	640 x 480 Dots Dot size: 0.06 x 0.06 mm (0.002 x 0.002 in)
Backlight	LED
<b>Electrical input and output</b>	
Number and type	banana-plug inputs for electrical parameters, resistance thermometers and thermocouples
Resistance thermometer (RTD)	Pt100 (385, 3616, 3906, 3926, 3923), Pt200, Pt500, Pt1000 (385, 3916), Ni100, Ni120, Cu10, Cu100
Thermocouples	Types J, K, T, F, R, S, B, U, L, N, E, C
Voltage signal	input: DC $\pm 100$ mV, $\pm 2$ V, $\pm 80$ V output: DC 20 V
Current signal	input: DC $\pm 100$ mA output: DC 20 mA <sub>1)</sub>
Frequency signal	0 ... 50,000 Hz
Pulses signal	1 ... 999,999
Resistance	0 ... 10,000 $\Omega$
Voltage supply	DC 24 V
<b>HART® communication</b>	
HART® module	based on HART® universal and common practice commands
Resistance	HART® resistance 250 $\Omega$ (activatable)
Loop current	max. DC 24 mA
Voltage supply	DC 24 V
<b>Pressure connection</b>	1/4" BSP (male) by PSP-1 external pressure sensor
<b>Permissible media</b>	non-corrosive gases and liquids
<b>Temperature compensation</b>	-10 ... +50 °C (14 ... 122 °F)
<b>Temperature coefficient</b>	0.001 % of reading/°C, outside of 19 ... 23 °C (66 ... 73 °F)
<b>Units</b>	bar, mbar, psi, psf, Pa, hPa, kPa, MPa, torr, atm, kg/cm <sup>2</sup> , kg/m <sup>2</sup> , mmHg (0 °C), cmHg (0 °C), mHg (0 °C), inHg (0 °C), mmH <sub>2</sub> O (4 °C), cmH <sub>2</sub> O (4 °C), mH <sub>2</sub> O (4 °C), inH <sub>2</sub> O (4 °C), ftH <sub>2</sub> O (4 °C)
<b>Voltage supply</b>	
Battery type	rechargeable battery NiMH
Battery life (fully-charged)	8 hours for typical usage (without backlighting)
Power supply	AC 100 ... 240 V, 50/60 Hz
<b>Permissible ambient conditions</b>	
Operating temperature	-10 ... +50 °C (14 ... 122 °F)
Storage temperature	-30 ... +80 °C (-22 ... +176 °F)
Relative humidity	Operating humidity: 10 ... 90 % r. h. (non-condensing) Storage humidity: 0 ... 90 % r. h. (non-condensing)

Case	
Material	Front panel aluminium
Ingress protection	IP54
Dimensions	305 x 210 x 90 mm (12 x 8.27 x 3.55 in)
Weight	approx. 3 kg (6 lbs 6 oz)

Ignition protection type for model Pascal E/IS	
ATEX directive	II 2G Ex ib IIC T4 Gb - T <sub>amb</sub> : -10 ... +50 °C
Connection values	
Max. voltage	U <sub>0</sub> = 29.7 V
Max. current	I <sub>0</sub> = 31 mA
Max. power	P <sub>0</sub> = 0.92 W
Max. effective internal capacitance	C <sub>0</sub> = 69 nF
Max. effective internal inductance	L <sub>0</sub> = 30 mH
Power supply circuit	
Max. voltage	U <sub>i</sub> = 30 V
Max. current	I <sub>i</sub> = 100 mA
Max. power	P <sub>i</sub> = 0.75 W
Max. effective internal capacitance	C <sub>i</sub> = negligible
Max. effective internal inductance	L <sub>i</sub> = negligible

### Approvals for Pascal ET/IS



Logo	Description	Country
	<b>EU declaration of conformity</b> <ul style="list-style-type: none"> <li>■ EMC directive EN 61326 emission (group 1, class B) and interference immunity (portable test and measuring equipment)</li> <li>■ Low voltage directive</li> <li>■ ATEX directive II 2G Ex ib IIC T4 Gb - T<sub>amb</sub>: -10 ... +50 °C</li> </ul>	European Union
	<b>IECEx</b> for IEC 60079-0, IEC 60079-11	IECEx member states
	<b>DNOP-MakNII</b> Hazardous areas	Ukraine

Base instrument	
<b>Voltage supply</b>	
Battery type	rechargeable battery NiMH
Battery life (fully-charged)	8 hours for typical usage
Power supply	AC 100 ... 240 V, 50/60 Hz
<b>Permissible ambient conditions</b>	
Operating temperature	-10 ... +50 °C (14 ... 122 °F)
Storage temperature	-30 ... +80 °C (-22 ... +176 °F)
Relative humidity	Operating humidity: 10 ... 90 % r. h. (non-condensing) Storage humidity: 0 ... 90 % r. h. (non-condensing)

Case	
Material	Front panel aluminium
Ingress protection	IP54
Dimensions	330 x 270 x 170 mm (13 x 10.6 x 7 in)
Weight	6 kg (13 lbs 2 oz)

Ignition protection type for model Pascal 100/IS	
ATEX directive	II 2G Ex ib IIC T4 Gb - T <sub>amb</sub> : -10 ... +50 °C
<b>Connection values</b>	
Max. voltage	U <sub>0</sub> = 29.7 V
Max. current	I <sub>0</sub> = 31 mA
Max. power	P <sub>0</sub> = 0.92 W
Max. effective internal capacitance	C <sub>0</sub> = 69 nF
Max. effective internal inductance	L <sub>0</sub> = 30 mH
<b>Power supply circuit</b>	
Max. voltage	U <sub>i</sub> = 30 V
Max. current	I <sub>i</sub> = 100 mA
Max. power	P <sub>i</sub> = 0.75 W
Max. effective internal capacitance	C <sub>i</sub> = negligible
Max. effective internal inductance	L <sub>i</sub> = negligible

### Approvals for Pascal ET/IS

Logo	Description	Country
	<b>EU declaration of conformity</b> <ul style="list-style-type: none"> <li>■ EMC directive EN 61326 emission (group 1, class B) and interference immunity (portable test and measuring equipment)</li> <li>■ Low voltage directive</li> <li>■ ATEX directive II 2G Ex ib IIC T4 Gb - T<sub>amb</sub>: -10 ... +50 °C</li> </ul>	European Union
	<b>IECEX</b> for IEC 60079-0, IEC 60079-11	IECEX member states
	<b>DNOP-MakNII</b> Hazardous areas	Ukraine

### Approvals for Pascal ET

GB

Logo	Description	Country
	<b>EAC</b> ■ Electromagnetic compatibility ■ Low voltage directive	Eurasian Economic Community
	<b>BelGIM</b> Metrology, measurement technology	Belarus

### Certificates

Certificate	
Calibration	3.1 calibration certificate per DIN EN 10204 option: ACCREDIA calibration certificate
Recommended recalibration interval	1 year (dependent on conditions of use)

Approvals and certificates, see website

Dimensions in mm (in)

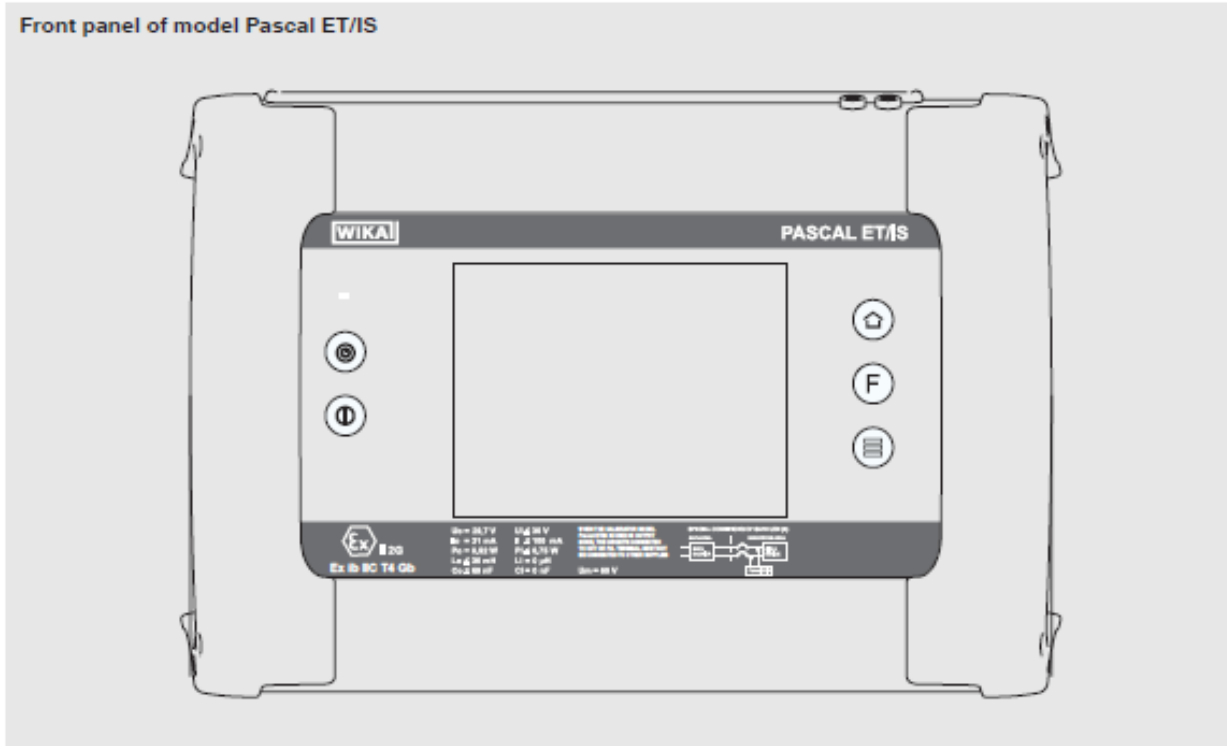
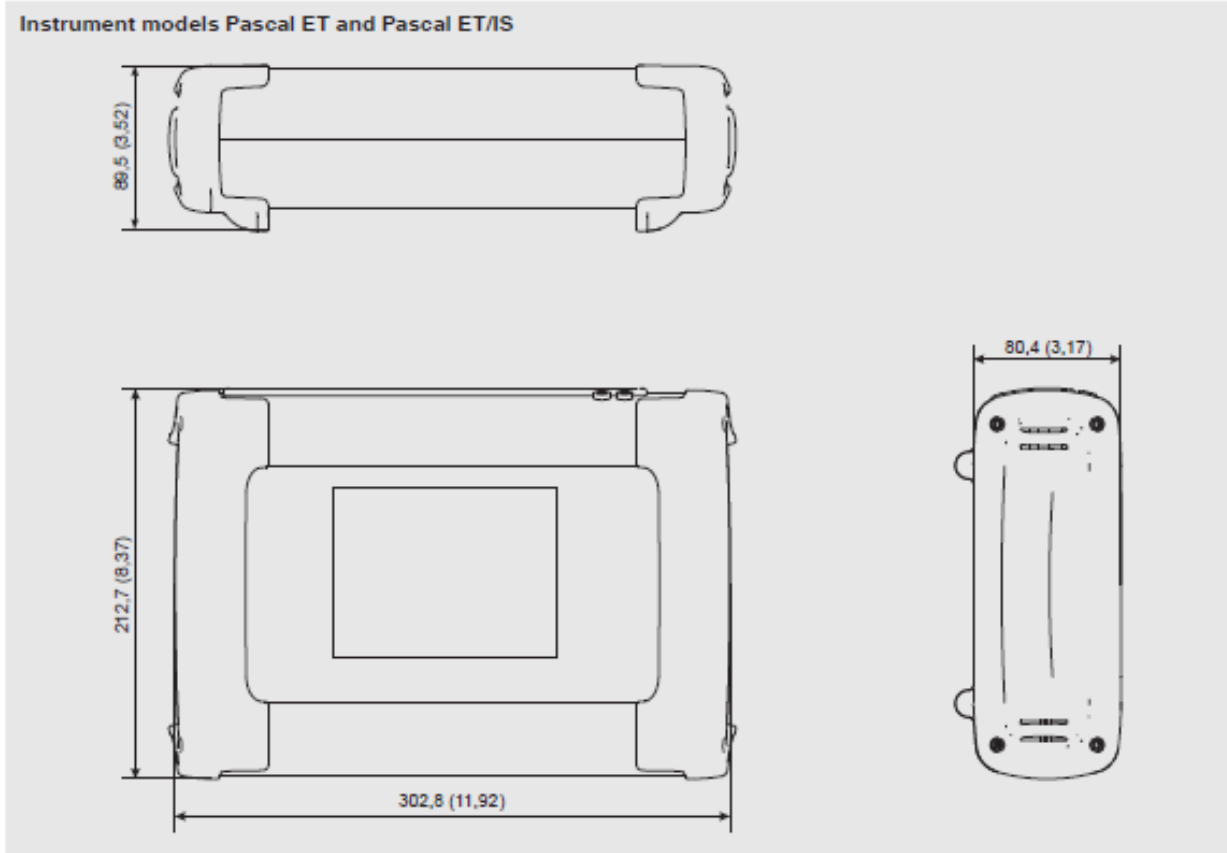

For further specifications see WIKA data sheet CT 18.02 and the order documentation.

## 4 Design and Function

GB

### 4.1 Description

Pascal ET, ET-P, ET/IS, ET-P/IS are the Professional Advanced Superior Calibrators of latest generation. User friendly interface by a wide display with an industrial touch screen through which it is possible to manage the instrument completely.

The operations are simplified thanks to the touch screen: the display changes in a dynamic way according to the user selections, following test by step the operator during the calibration process, decreasing the learning time and the human errors.

The touch screen can be operated by nude or gloved hands: dirty parts can be easily removed with a cloth or a sponge. The touch screen can be locked during the measurement process to avoid unintentional pressing of keys.

The backlight illumination with LED guarantees a perfect view in case of low environmental visibility. Five keys are present below the touch screen: turn on/off of the instrument, contrast settings and backlight.

The electrical part of Pascal ET, ET-P, ET/IS, ET-P/IS consists from two until 4 electrical modules to be selected between the available ones (2 inputs (IN) – 2 outputs (OUT) – one HART module) for measuring and generating mA, mV, V, Hz, Ohm, Pulse, TC/RTD.

The Pascal ET, ET-P, ET/IS, ET-P/IS consists of two parts: pressure part and electrical one.

The pressure part consists of one or two connectors for connecting the external pressure sensors:

- pneumatic distribution block
- internal manual vacuum/pressure generator with fine adjustment
- up to four internal pressure sensors with overpressure valves.

The electrical part consists of up to four electrical module (2 inputs (IN), 2 outputs (OUT) and a HART module) for the measurement and generation of mA, mV, V, Hz, Ohm, Pulse, TC/RTD.

On the side panel of the instrument there are several connectors for:

- recharging the battery
- RS232 port
- Connection to the external pressure transducers
- Connection for the environment parameters (temperature, humidity and atmospheric pressure)

Moreover there are the connections to provide 24 V d.c. power supply to the device under test.

The Pascal ET, ET-P, ET/IS, ET-P/IS is powered with an internal battery pack. The battery allows 6 hours of standard operation before recharging.

Operating Pascal ET, ET-P, ET/IS, ET-P/IS user is able to calibrate the whole industrial instrumentation like for example:

- Electronic and pneumatic pressure/vacuum transmitter
- Electronic and pneumatic differential pressure transmitter
- Electronic and pneumatic temperature transmitter (thermocouple and RTD)
- Signal converter V, mV, mA, Hz, Pulse, ohm
- Signal converter I/P and P/I
- Signal isolator mA, mV
- Mathematical Device (adder, subtractor, multiplier, divider)
- Manometer, Pressure switch
- Temperature monitor switch
- Thermocouple and thermoresistance
- Compensation device (up to 4 in-out signals)
- Electronic and pneumatic receiver
- Electronic and pneumatic controller
- Electronic and pneumatic recorder
- Miscellaneous instrument



Pascal ET, ET-P, ET/IS, ET-P/IS includes different modules and can be ordered with different hardware configurations.

The hardware configuration depends on the installation of different functional modules:

- Two electrical/temperature IN modules (IN A & IN B)
- Two electrical/temperature OUT modules (OUT A & OUT B)
- One pressure module able to support up to two transducers (2 internal, 2 external or a combination of both)
- One environment parameters module (atmospheric pressure, ambient temperature and relative humidity)
- One power supply 24 V d.c.
- One RS-232 communication port
- One connection for recharging the battery



### **Battery Life**

In order to preserve battery life is recommended to keep the battery charger connected for no more than 36 hours



### **Functional module**

A functional module is a hardware component that allows the Pascal ET or Pascal ET/IS to perform some operations like for example measurement and generation of electrical signals and pressure.

## **4.2 Scope of delivery**

- Portable multifunction calibrator model Pascal ET or Pascal ET/IS
- Operating instructions
- AC adapter
- Pascal report software
- RS-232 interface cable
- RS-232 to USB adapter
- Electrical kit order no. 241076
- Pneumatic pressure kit order no. 241028 and 241029 (Depending on pressure range)
- 3.1 calibration certificate per DIN EN 10204

Cross-check scope of delivery with delivery note.

## **4.3 Power supply**

### **Charging**

To avoid false measurements, charge the rechargeable batteries as soon as the battery indicator appears. If the batteries run too low the Pascal ET, ET-P, ET/IS, ET-P/IS will automatically shut down.



Use only the original AC/DC converter which is supplied by WIKA

### 5 Transport, packaging and storage

GB

#### 5.1 Transport

Check the Multichannel Calibrator model Pascal ET, ET-P, ET/IS, ET-P/IS for any damage that may have been caused by transport. Obvious damage must be reported immediately.

#### 5.2 Packaging

Do not remove packaging until just before mounting.

Keep the packaging as it will provide optimum protection during transport (e.g. sending for calibration).

#### 5.3 Storage

##### Permissible conditions at the place of storage:

- Storage temperature: -30 ... +80 °C
- Relative Humidity: 10 ... 90 % r. H. (non-condensing)

##### Avoid exposure to the following factors:

- Direct sunlight or proximity to hot objects
- Mechanical vibration, mechanical shock (putting it down hard)
- Soot, vapour, dust and corrosive gases
- Potentially explosive environments, flammable atmospheres

Store the instrument in its original packaging in a location that fulfills the conditions listed above. If the original packaging is not available, pack and store the instrument as described below:

1. Wrap the instrument in an antistatic plastic film.
2. Place the instrument, along with shock-absorbent material, in the packaging.
3. If stored for a prolonged period of time (more than 30 days), place a bag, containing a desiccant, inside the packaging.

## 6 Commissioning, operation

### 6.1 Commissioning

#### 6.1.1 Instrument overview

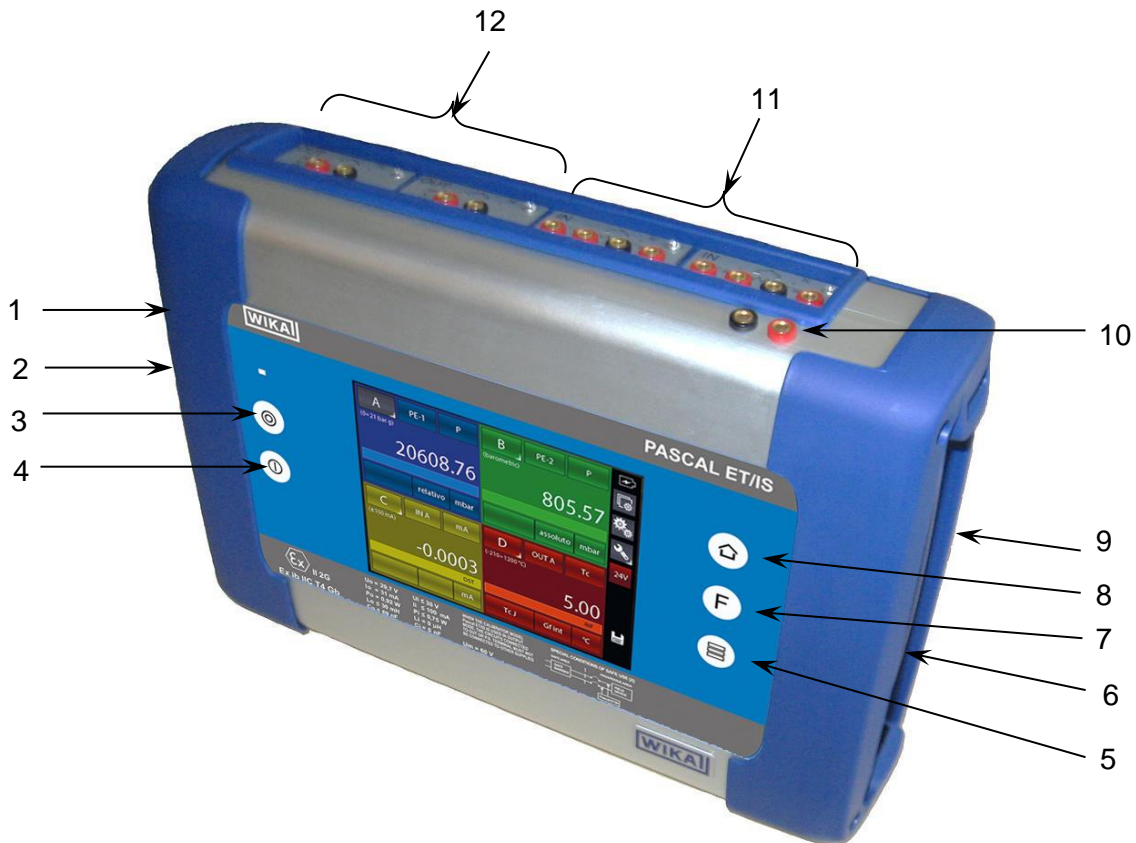

- 1 **RS-232** port
- 2 Connector for **battery charger**
- 3 **Power ON**
- 4 **Power OFF**
- 5 Changing the number of windows
- 6 Connectors for **external P transducer**
- 7 Programmable Function
- 8 Home
- 9 **Environmental Parameter** Connector
- 10 **Loop power supply** – 24 V d.c.
- 11 **IN** electrical/temperature modules
- 12 **OUT** electrical/temperature modules

#### 6.1.2 Functional Modules

The functional modules can be classified according to their assignments:

- Electrical and temperature signals measurement
- Pressure measurement, (2 different modules, up to 4 internal pressure sensors and 2 connectors for external pressure sensor)
- Electrical and temperature signals generation/simulation
- Pressure generation and regulation
- Environmental parameters measurement

Many different configurations are available according to the specific requirements of the user.

### 6.1.2.1 Input module for electrical/temperature signals

The input module for electrical/temperature parameters measurement is one of those modules inserted from the instrument's front panel; two slides drive the module into its position. It is possible to have up to two input modules in the same instrument: IN A and IN B. This terminology is used also by the software to carry out the connection between physical input IN and software channel. For example: if you connect a thermoresistance Pt100 to module IN A, the temperature measured by this thermoresistance can be displayed in any of the four available windows. The following figure shows the pins connection in electrical/temperature IN module.

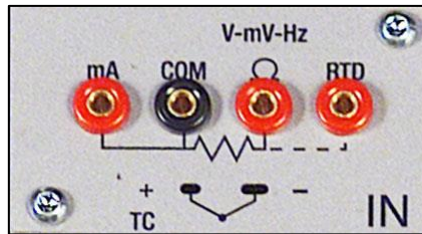

Figure 1 – Input panel module

### 6.1.2.2 Output module for electrical/temperature signals

The output module for electrical/temperature parameters generation or simulation is one of those inserted from the instrument's front panel; two slides drive the module into its position. It is possible to have up to two output modules in the same instrument: OUT A and OUT B. This terminology is used also by the software to carry out the connection between physical output OUT and software channel. For example: if you connect a signal-receiver to module output OUT A, the current 4...20 mA generated can be displayed in any of the four available windows.

The following figure shows the output module for electrical/temperature parameters.

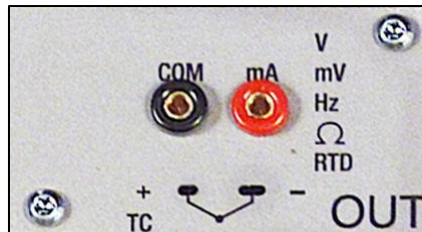

Figure 2 – Output panel module

The 2 INPUT cards and 2 OUTPUT cards are plug and play modules and can be installed by the user himself.

### 6.1.2.3 Pressure module

The pressure module is installed only at factory location in accordance with the Pascal ET, ET-P, ET/IS, ET-P/IS configuration required. It is possible to install one pressure modules, able to support up to two transducers (2 internal, 2 external or a combination of both). Transducer's selection with range and their resolutions are in the following table.

#### Internal transducers \*

Range	Precision (% FS)	Accuracy (% FS)	Typical Resolution
<b>Gauge</b>			
-60...+60 mbar	0.1	0.15	0.001 mbar
-500...+500 mbar	0.015	0.025	0.001 mbar
-900...+1500 bar	0.015	0.025	0.01 mbar
0...7 bar	0.015	0.025	0,1 mbar
0...21 bar	0.015	0.025	0.1 mbar
0...50 bar	0.015	0.025	1 mbar
0...100 bar	0.015	0.025	1 mbar
<b>Absolute</b>			
600...1300 mbar abs.	0.015	0.025	0.01 mbar
0...1500 mbar abs.	0.015	0.025	0.01 mbar
0...2500 mbar abs.	0.015	0.025	0.01 mbar
0...5 bar abs.	0.015	0.025	0.1 mbar
0...7 bar abs.	0.015	0.025	0.1 mbar
0...21 bar abs.	0.015	0.025	0.1 mbar
0...81 bar abs.	0.015	0.025	1 mbar
0...100 bar abs.	0.015	0.025	1 mbar

#### External transducers \*

Range	Precision (% FS)	Accuracy (% FS)	Typical Resolution
<b>Gauge</b>			
-60...+60 mbar	0.1	0.15	0.001 mbar
-500...+500 mbar	0.015	0.025	0.001 mbar
-900...+1500 bar	0.015	0.025	0.001 mbar
0...7 bar	0.015	0.025	0.1 mbar
0...21 bar	0.015	0.025	0.1 mbar
0...50 bar	0.015	0.025	1 mbar
0...100 bar	0.015	0.025	1 mbar
0...200 bar	0.015	0.025	10 mbar
0...400 bar	0.015	0.025	100 mbar
0...700 bar	0.025	0.05	100 mbar
0...1000 bar	0.025	0.05	100 mbar
<b>Absolute</b>			
0...1500 mbar abs.	0.015	0.025	0.01 mbar
0...2500 mbar abs.	0.015	0.025	0.01 mbar
0...5 bar abs.	0.015	0.025	0.1 mbar
0...7 bar abs.	0.015	0.025	0.1 mbar
0...21 bar abs.	0.015	0.025	0.1 mbar
0...81 bar abs.	0.015	0.025	1 mbar
0...100 bar abs.	0.015	0.025	1 mbar

\* Other ranges available on request

### 6.1.2.4 HART module

The HART module allows communication with HART instruments (usually transmitters) permitting to acquire digital measurements, instrument data and modifying settings. It can be inserted in the front panel in place of OUT A or OUT B module.

It is a fully galvanically isolated board (like IN and OUT modules) from internal electronics of the Pascal.

The module allow the 24V to supply directly the output loop for the transmitter. Further, it can supply a 250Ω load resistance electronically switchable necessary to HART communication, permitting to avoid the use of an external one.

GB

The following figure shows the pin connections in HART module:



Figure 3 – HART module

6.1.2.4.1 HART wiring

Depending by several factors and combination that the user can found in a plant, there are many wiring possibility depending by:

- Using module internal or external Power Supply.
- Using internal or external load resistance.
- Simultaneous analog connection of AO TRX to one Input module for mA reading

Please consider, if the user enable the internal load resistance, this will be connected between the +HART and COM terminals.

Here same examples:

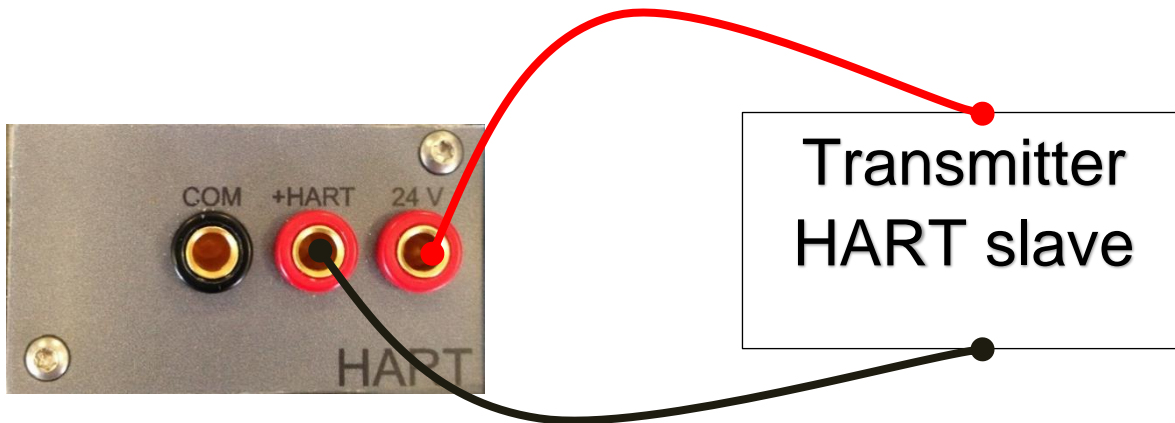

Figure 4 - Case 1: 24V from module, 250Ω from module

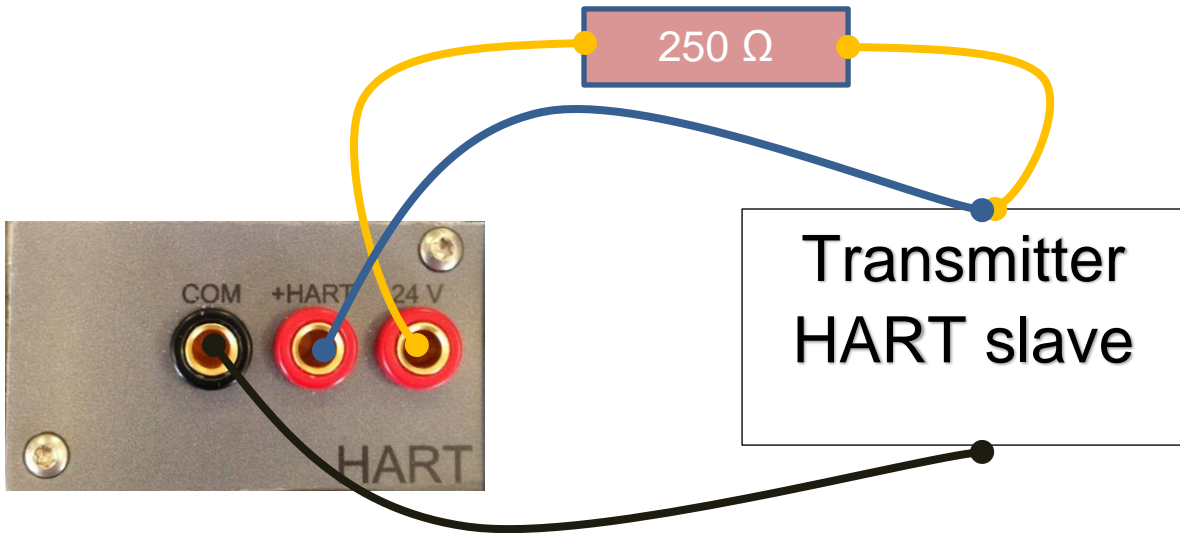

Figure 5 - Case 2: 24V from module, 250Ω external

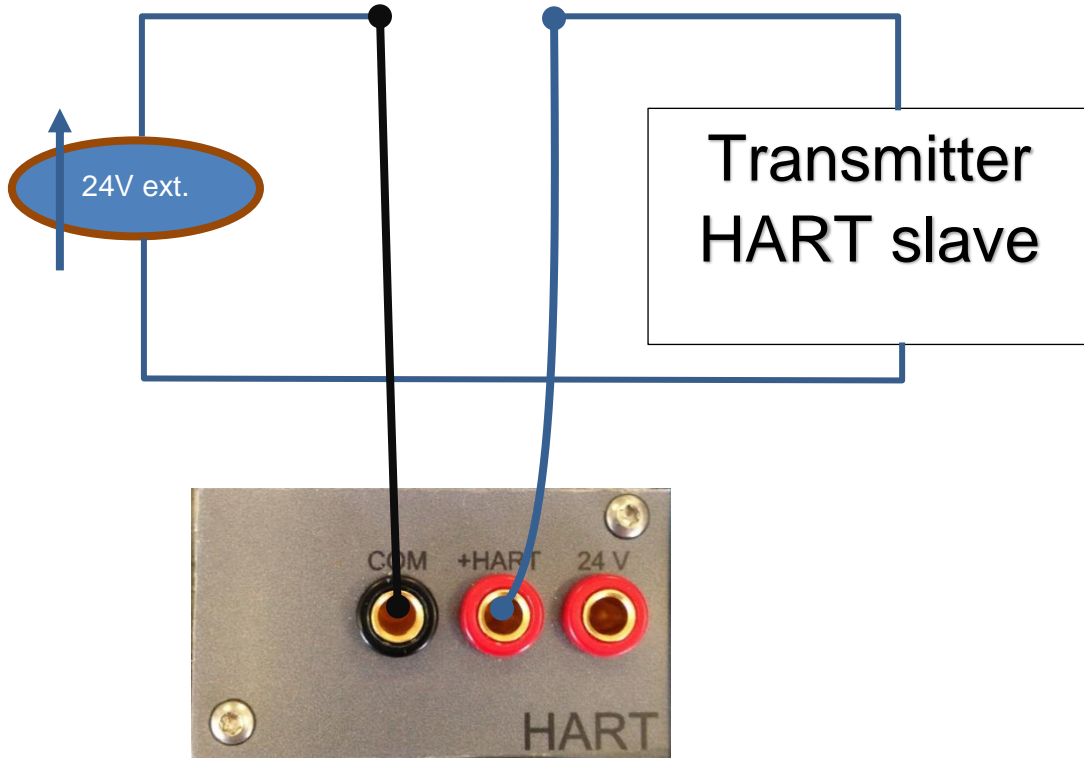

Figure 6 - Case 3: 24V external, 250Ω from module

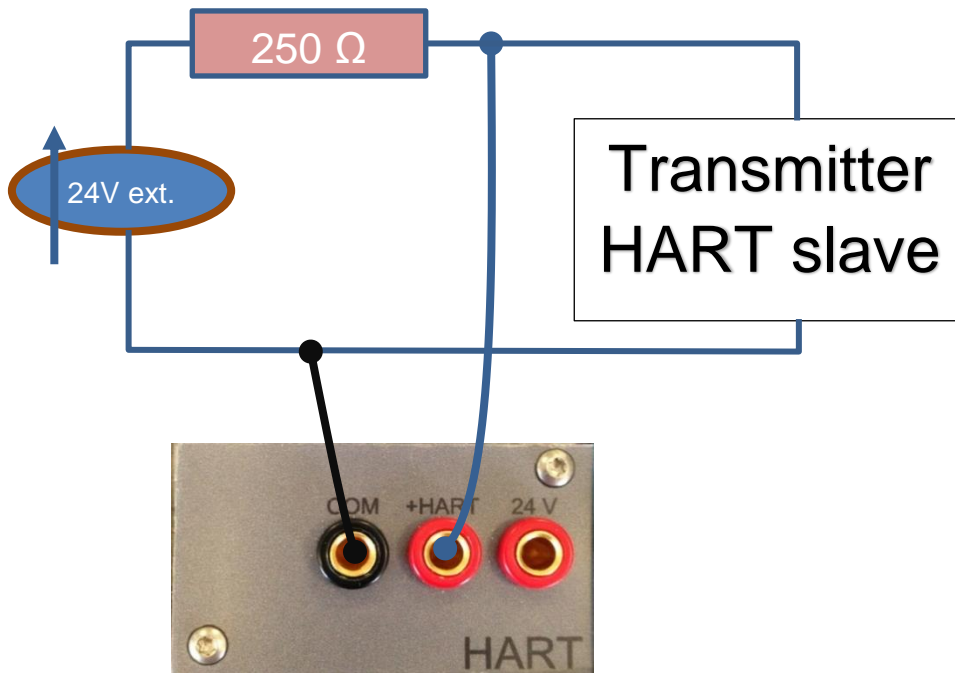

Figure 7 - Case 4: 24V external, 250Ω external

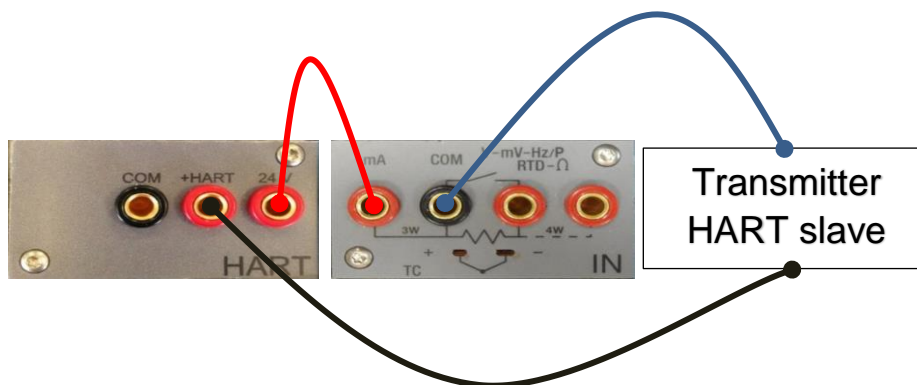

Figure 8 - Case 8: 24V from module, 250Ω from module, mA reading by IN module

### 6.1.2.5 Environmental parameters module (optional)

This module allows to measure: temperature, relative humidity and atmospheric pressure. These parameters represent the most important factors that affect the calibration results. This module is connected to Pascal ET, ET-P, ET/IS, ET-P/IS with a multiple pin connector present in Pascal ET, ET-P, ET/IS, ET-P/IS front panel. This module is plug & play and the relevant information about the environmental parameters are displayed on the status bar at the top of the screen. This information is automatically reported on the calibration report.

Parameter	Range	Precision	Uncertainty	Max. resolution
Temperature	-10 ... +50 °C	2.7 °C	3.0 °C	0,1 °C
Barometric pressure	650 ... 1150) mbar	4 % fs	5 % fs	1 mbar
Relative humidity	10 ... 90 %	12 %	15 %	1 %

## 6.2 Electrical

The Pascal ET, ET-P, ET/IS, ET-P/IS are multifunction calibrators.

The electrical modules can be maximum four, two of them are input modules (IN A – IN B), and the other two are output modules (OUT A – OUT B).



### 6.2.1 Electrical measurements

The instrument is able to measure voltage, current, resistance and frequency. To optimize the resolution and get better measurement results, there are three ranges for voltage measurement, two for resistance measurements, one range for current and three ranges for frequency. Ranges of measurement and resolutions are specified in following table:

Range	Max resolution
<b>Voltage</b>	
(-100...100) mV	0.0001 mV
(-2...2) V	0.000001 V
(-80...80) V	0.00001 V
<b>Current</b>	
(-100...100) mA	0.0001 mA
<b>Resistance</b>	
(0...400) $\Omega$	0.001 $\Omega$
(0...10000) $\Omega$	0.01 $\Omega$
<b>Frequency</b>	
(0.4...50000) Hz	0.001 Hz
<b>Pulse</b>	
0,4...20 Hz	-
<b>Contact</b>	
Open - Closed	-

Table 1 - Range of input signals

### 6.2.2 Thermocouple measurements

The electrical module measures signals from the thermocouple and shows it in different engineering units (°C, °F, K).

GB

Thermocouple types, measuring range, linearity error and related resolutions are given in the following table:

Type	Range/°C	Resolution/°C Max
J	-210...1200	0.1
	-190...1200	0.01
K	-270...1370	0.1
	-160...1260	0.01
T	-270...400	0.1
	-130...400	0.01
F	0...1400	0.1
	0...1400	0.01
R	-50...1760	0.1
	150...1760	0.01
S	-50...1760	0.1
	170...1760	0.01
B	50...1820	0.1
	920...1820	0.01
U	-200...400	0.1
	-160...400	0.01
L	-200...760	0.1
	-200...760	0.01
N	-270...1300	0.1
	0...1300	0.01
E	-270...1000	0.1
	-200...1000	0.01
C	0...2300	0.1
	0...2000	0.01
M	-50...1410	0.1
	-50...1410	0.01

Table 2 – Thermocouple measurements table

It is possible to perform the measurement in two different ways: with internal reference (cold junction), with external reference cold junction by entering the reference value through the keyboard. When internal reference cold junction is selected, the ambient temperature is measured through the thermocouple pins using a special thermoresistance. This temperature value is used for compensation. The Standard connector Mignon for thermocouple is shown in Figure 1. The thermoresistance for compensation of the reference cold junction is integrated in the same connector.

### 6.2.3 Thermoresistance measurements

The electrical module measures signals from thermoresistance and shows it in different engineering units (°C, °F, K).

Thermoresistance types, measuring range and related resolutions are given in the following table:

Type	Range/°C	Resolution/°C Max
Pt100 (385)	-200...850	0.1
	-200...850	0.01
Pt100 (3916)	-200...850	0.1
	-200...850	0.01
Pt100 (3926)	-200...850	0.1
	-200...850	0.01
Pt100 (3902)	-200...650	0.1
	-200...650	0.01
Pt100 (3923)	-200...600	0.1
	-200...600	0.01
Pt100 JIS (3916)	-200...600	0.1
	-200...600	0.01
Pt200 (385)	-200...850	0.1
	-200...850	0.01
Pt500 (385)	-200...850	0.1
	-200...530	0.01
Pt1000 (385)	-200...850	0.1
	-200...850	0.01
Pt1000 (3916)	-200...850	0.1
	-200...850	0.01
Ni100 (617)	-60...180	0.1
	-60...180	0.01
Ni120 (672)	0...150	0.1
	0...150	0.01
Cu10 (42)	-70...150	0.1
	-70...150	0.01
Cu100	-180...150	0.1
	-180...150	0.01

Table 3 - Thermoresistance measurements table

It is possible to connect the thermoresistance according to the type of measurement: 2 wires, 3 wires and 4 wires. The two wires measurement is performed without any compensation of the connecting cables resistances; in this case the connection is among the two central (COM - Ω) pins. In the case of three wires connection the pin identified with the writing 3W must also be used. While for the four wires measurement, the most accurate of the above, is performed by using all four pins.

### 6.2.4 Generation of electrical parameters

The output module (OUT) allows to generate voltage, current, resistance and frequency.

For the voltage there are three different ranges with different resolutions. Resistance has two ranges while current and frequency have only one range. Ranges and resolutions are given in the following table:

Range	Max resolution
<b>Voltage</b>	
(0...100) mV	0.0001 mV
(0...2) V	0.000001 V
(0...20) V	0.00001 V
<b>Current</b>	
(0...20) mA	0.0001 mA
<b>Resistance</b>	
(0...400) Ω	0.001 Ω
(0...10000) Ω	0.01 Ω
<b>Frequency</b>	
(0,5...20000) Hz	0.001 Hz
<b>Pulse</b>	
(0,5...200) Hz / 9999999 impulse	

Table 4 – Range of output signals

### 6.2.5 Thermocouple simulation

Through the output module it is possible to simulate thermocouples. This function can be used to test and calibrate: thermocouple transmitters, analogue or digital indicator. A thermoresistance Pt100, inserted in isothermal contact with the connectors, measures the ambient temperature for the cold junction compensation. It is possible to disable the automatic cold junction compensation and set out the reference temperature by the keyboard.

The instrument can simulate thermocouple types indicated in the following table:

Type	Range/°C	Resolution/°C Max
J	-210...1200	0.1
	-190...1200	0.01
K	-270...1370	0.1
	-160...1260	0.01
T	-270...400	0.1
	-130...400	0.01
F	0...1400	0.1
	0...1400	0.01
R	-50...1760	0.1
	150...1760	0.01
S	-50...1760	0.1
	170...1760	0.01
B	50...1820	0.1
	920...1820	0.01
U	-200...400	0.1
	-160...400	0.01
L	-200...760	0.1
	-200...760	0.01
N	-270...1300	0.1
	0...1300	0.01
E	-270...1000	0.1
	-200...1000	0.01
C	0...2300	0.1
	0...2000	0.01
M	-50...1410	0.1
	-50...1410	0.01

Table 5 – Thermocouple simulation table

### 6.2.6 Thermoresistance simulation

Through the output module (OUT) it is possible to simulate thermoresistance. This function can be used to check and calibrate: temperature transmitters – analogue or digital indicators. The instrument can simulate thermoresistance types indicated in the following table:

Type	Range/°C	Resolution/°C Max
Pt100 (385)	-200...850	0.1
	-200...850	0.01
Pt100 (3916)	-200...850	0.1
	-200...850	0.01
Pt100 (3926)	-200...850	0.1
	-200...850	0.01
Pt100 (3902)	-200...650	0.1
	-200...650	0.01
Pt100 (3923)	-200...600	0.1
	-200...600	0.01
Pt100 JIS (3916)	-200...600	0.1
	-200...600	0.01
Pt200 (385)	-200...850	0.1
	-200...850	0.01
Pt500 (385)	-200...850	0.1
	-200...530	0.01
Pt1000 (385)	-200...850	0.1
	-200...850	0.01
Pt1000 (3916)	-200...850	0.1
	-200...850	0.01
Ni100 (617)	-60...180	0.1
	-60...180	0.01
Ni120 (672)	0...150	0.1
	0...150	0.01
Cu10 (42)	-70...150	0.1
	-70...150	0.01
Cu100	-180...150	0.1
	-180...150	0.01

Table 6 – Thermoresistance simulation table



#### Fast programming of the value to be simulated

In generation or simulation on any particular channel the simulated value can be rapidly changed by pressing immediately to the right of the simulated value. By pressing the displayed value a virtual numerical keyboard appears.

### 6.3 User Interface

The Pascal ET, ET-P, ET/IS, ET-P/IS calibrator has a wide display with touch screen through which it is possible to set up the instrument.

GB

The 1-, 2- or 3-window display mode shows a right column containing the following information:

- Ambient temperature
- Barometric pressure
- Relative humidity
- Battery charge status – power supply
- Data Logger status
- Date
- Time
- Keys for channel/instrument/global functions

The following figure shows the typical display of the calibrator.

NOTE: some keys include a white semi-triangle symbol on the bottom right side: it indicates that the button has different function. It allows to activate 2 different actions, depending on the short or long pressing of the button itself.

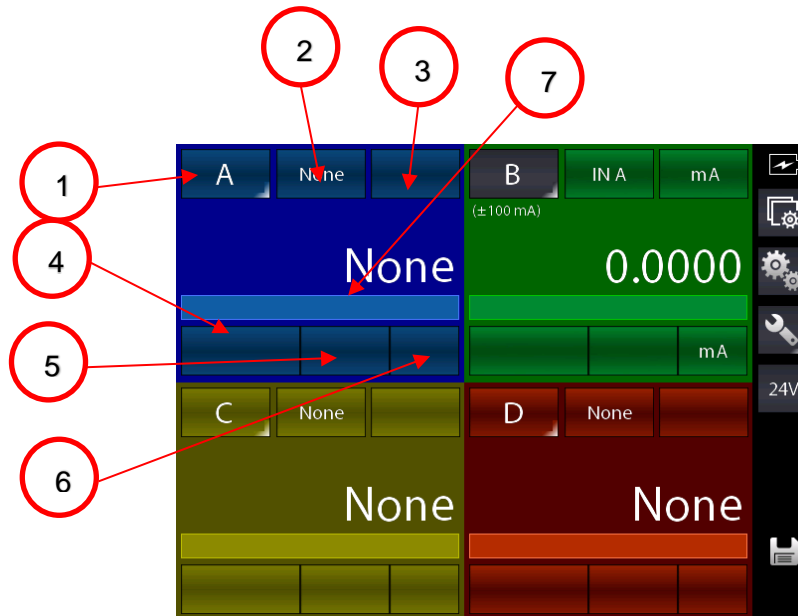



Figure 9 – Typical display of Pascal ET, ET-P, ET/IS, ET-P/IS with 4 windows

The display shows up to four windows (channels) that can be switched from one to four by using

the button : Each windows can be also assigned to a different channel, related to its functional module, and according to the user requirement.

The description for the 7 available areas are as follows:

1. Key for Selection / Assignment of the channel letter to the active window
2. Key for selecting the source for module IN / OUT / P / Key
3. Key for selecting the field of the selected module (where applicable)
4. Key for selecting the sub-field of the selected module (where applicable)
5. Key for selecting the field options of the selected module (where applicable), i.e. Tc or Rtd type
6. Key for selecting the unit of the selected field (where changeable)
7. Line for display status messages when active (i.e. filter, ramp, offset, etc...).

The picture above shows the calibrator set for current signal generation (0-20 mA) with values indicated on the channel B window. The other channels are not configured.

The column on the right that appears with the 4-window display mode shows the basic information and always shows 4 buttons for the following functions:

1. Channel settings
2. Instruments functions
3. General settings
4. Enable/Disable P.S. 24 V DC

Compared to the display mode for one single channel, the 1- or 2-window display mode shows additional information as follows:

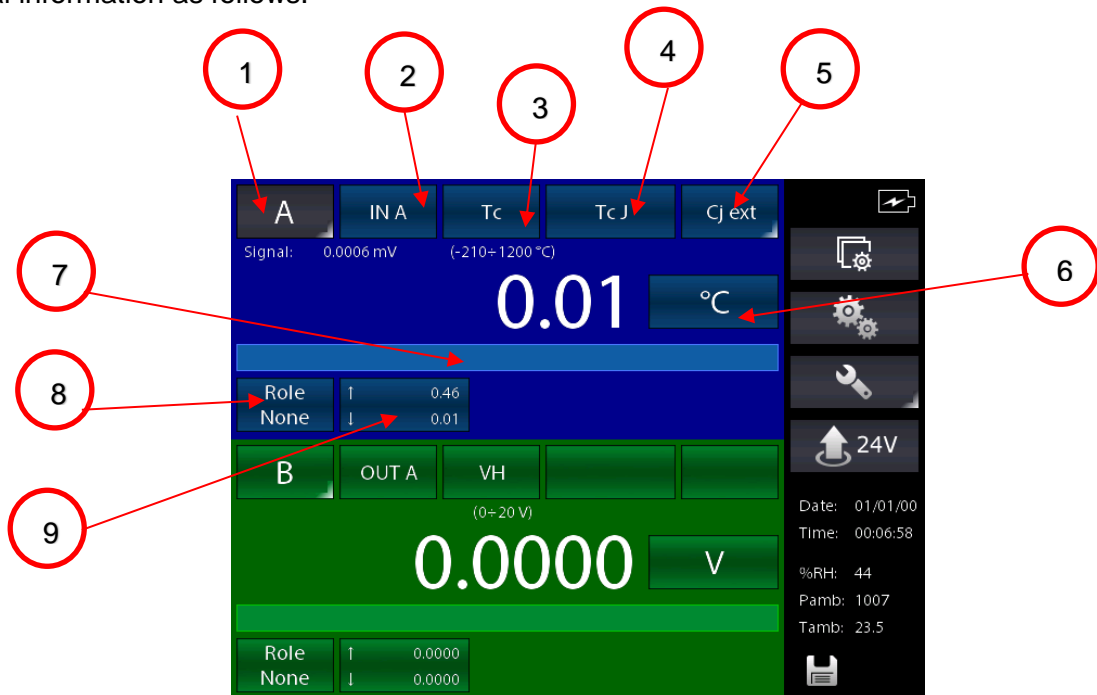

Figure 10 – Typical display of Pascal ET, ET-P, ET/IS, ET-P/IS with 4 windows

8. Selection of the Channel Role (None, REF, DST)
9. MAX and MIN values indication. Press the button to reset data

### 6.3.1 Channel configuration

The assignment of a function to a software channel is a simple and intuitive procedure. The channel assignments are very similar and independent for each channel.

GB

The calibrator manage 4 channels identified by the letters from A to D. Each display window can shows the information of the desired channel by selecting the corresponding letter.

The following procedure shows how to configure the “**C**” **channel** on the first window and how to set up the Pascal ET, ET-P, ET/IS, ET-P/IS for temperature measurement through a Pt100 thermoresistance connected to the input pins of the IN A module (using 4 wires measurement). The selection of one of the four available channels is made by pressing the channel letter on the displays, as shown in the figure below.



#### Channel selection

To verify if the channel has been correctly selected it is possible to check if the button indicating the Channel Letter located in the top left corner of the corresponding Channel Window, is indicated in white on grey background or not. See figure below.

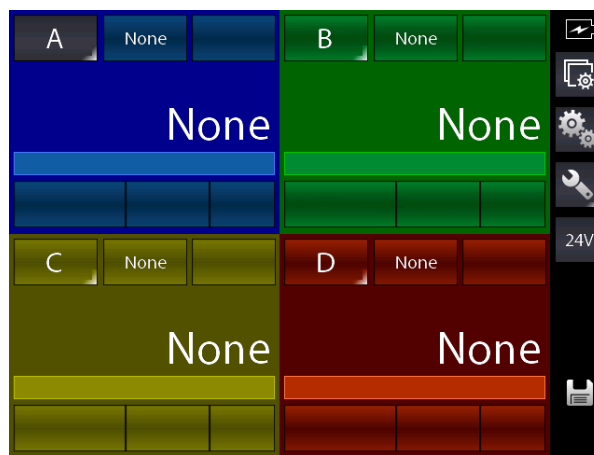

Figure 11 – Channel A selected



At first you should change the Channel Letter assignment on the first window by pressing and keeping pressed the letter button for few seconds (indicated with “Q” in the picture below) until the letter changes into “C”.

By pressing the letter button quickly activates the channel: the button displays a grey background when active.

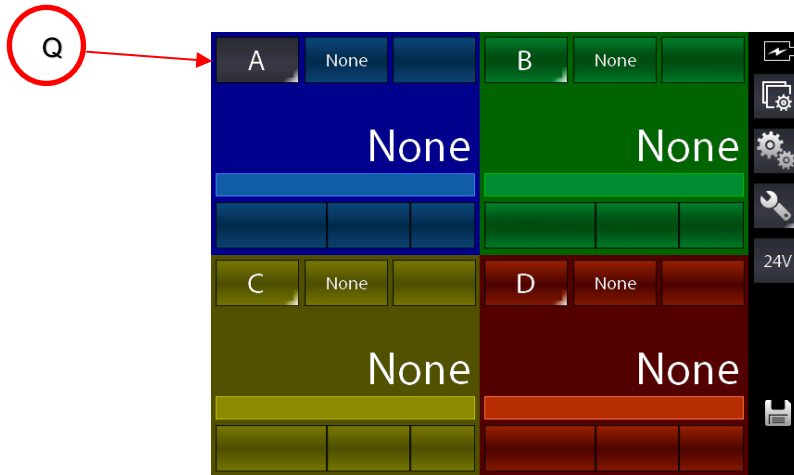

Figure 12 – Changing the Channel Letter

By pressing and keeping pressed the key Q the following screen appears:

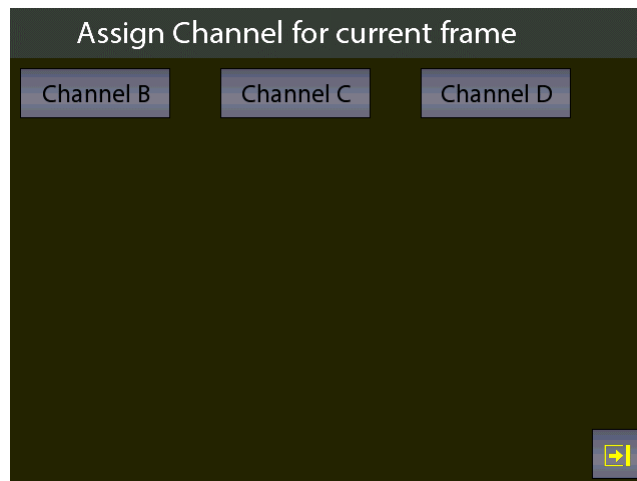

Figure 13 – Selecting the Channel Letter

Press the “Channel C” button to assign the Channel.

The screen changes as follows:

GB

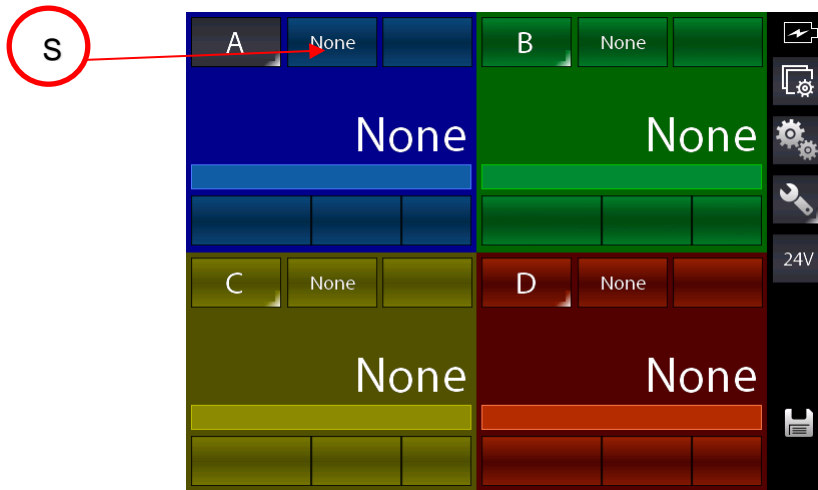

Figure 14 – First window assigned to Channel “C”

Press the key indicated with “S” to select the module for Rtd measuring. The following screen appears (depending on the installed modules):

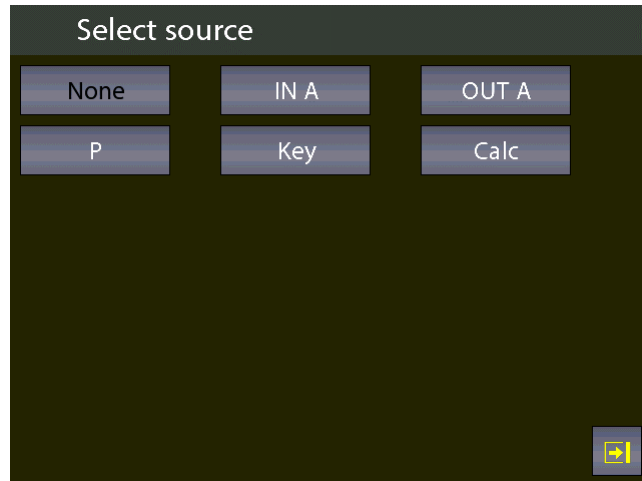

Figure 15 – Source selection

As we need to measuring from the input, select the option “IN A”: The screen will change as follows:

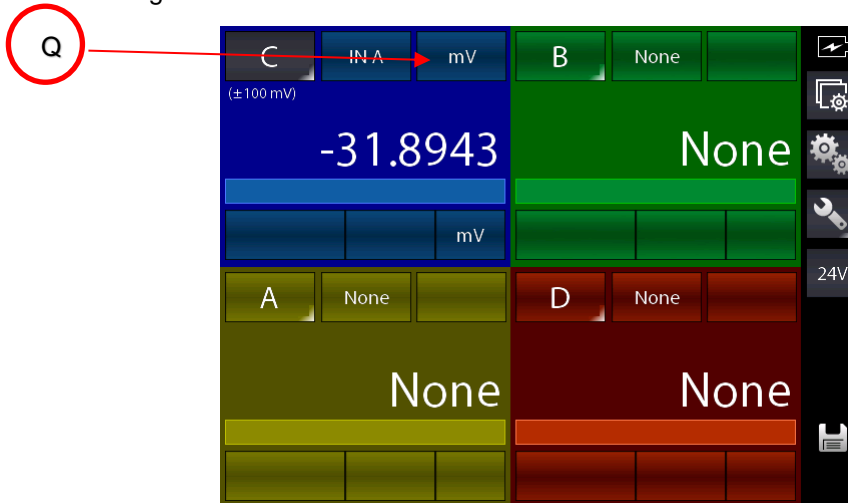

Figure 16 – IN A Selected

The calibrator set the selected option and load the last used unit for the module (in this case the last used measuring unit was the mV measuring). To change the measuring unit in Rtd press the key indicated with “Q” in the figure above:

The following screen appears:

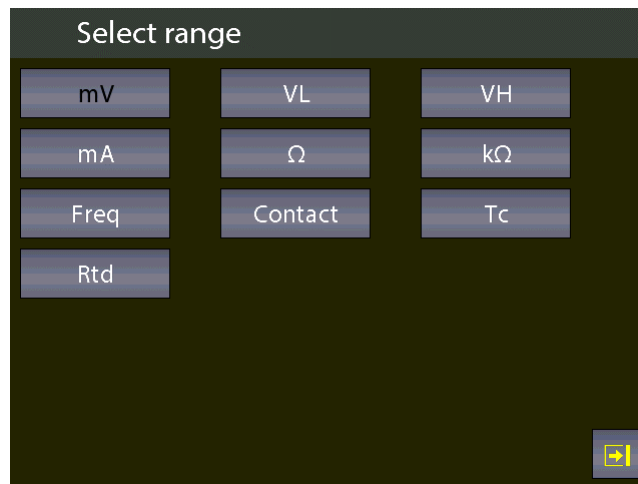

Figure 17 – Selecting the unit for module IN A

By selecting the “Rtd” unit the screen changes as follows:

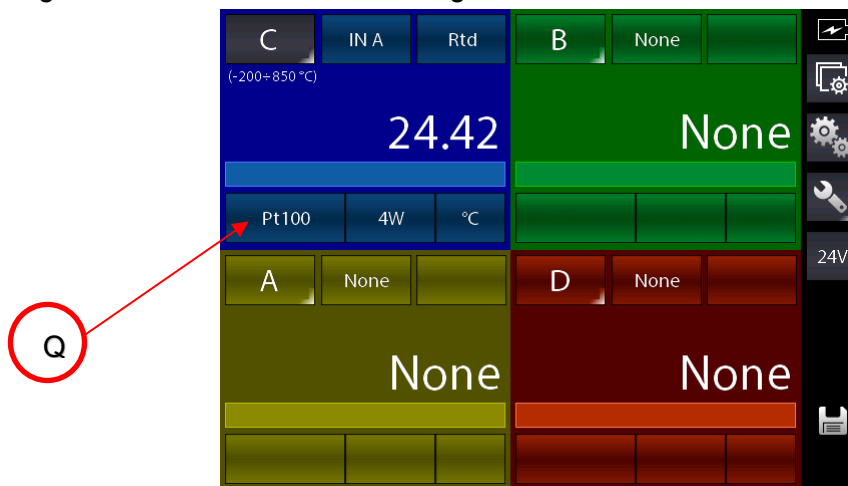

Figure 18 – Module IN A with Rtd unit selected

The calibrator set the unit in Rtd and shows the last used Rtd type (in this case the last used Rtd type was Pt100 IEC).

It is also possible select an Rtd type “User” if not listed in the pre-defined options.

To select the Rdt type “User” press the button indicated with “Q” on the figure above.

The following screen appears:

GB

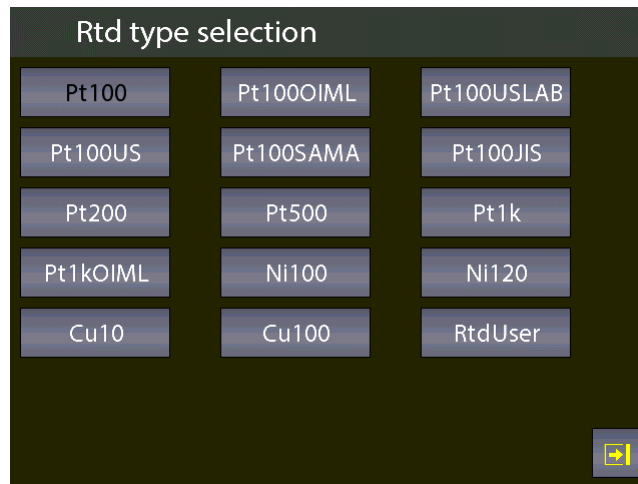

Figure 19 – Selecting the Rtd type

Press the button “RtdUser” and the screen will change as follows:

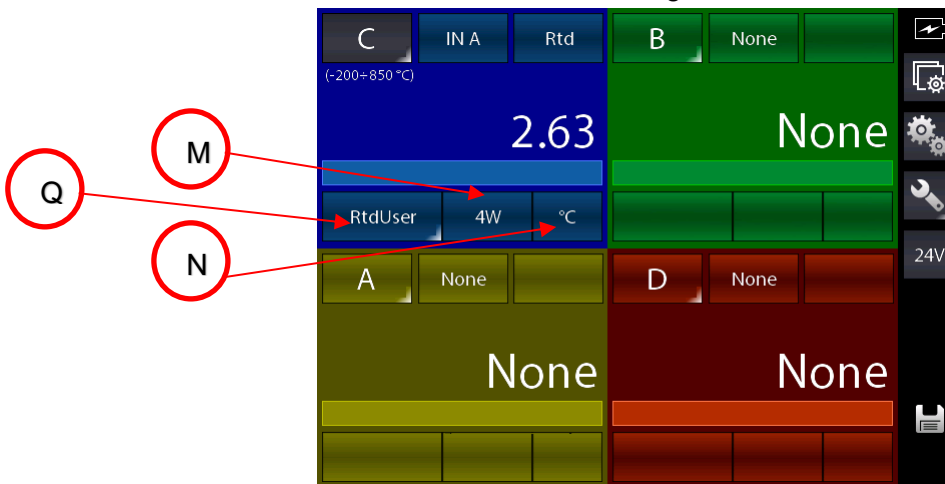

Figure 20 – IN A module with RtdUser selected

The calibrator is now set for measuring an RtdUser by using the 4-wire (4W) “IN A” input and displaying the temperature in °C.

The button indicated with “Q” in the picture above now shows a little with triangle in the right-down corner: this symbol indicated “Q” that if the button will be pressed for long time, a different function can be selected. By pressing and keep pressed that button you can enter the pages for setting the desired parameters related to the custom or user thermoresistance (Ptd).

The following screen appears:

Rtd parameters setup	
A Coeff.	35.0000
B Coeff.	-5.8330
C Coeff.	-4.2060
Resistance	100.000

Figure 21 – Setting parameters for RtdUser



#### Measurements of RTD - 4-wire

If possible it is recommended to perform RTD measurement with four wires to eliminate parasite resistances of the connecting cables. All specifications for thermoresistance aim for four wires measurement.

RTD USER must be selected when the operator needs to measure a non-standard RTD in agreement with the following formula:

$$\text{If } T \geq 0 \text{ } ^\circ\text{C } R(t) = R_0 * (1 + A * t + B * T^2)$$

$$\text{If } T < 0 \text{ } ^\circ\text{C } R(t) = R_0 * (1 + A * t + B * T^2 + C (t - 100) * t^3)$$

Where:

$$A = X * 10^{-3} \text{ } ^\circ\text{C}^{-1}$$

$$B = X * 10^{-7} \text{ } ^\circ\text{C}^{-2}$$

$$C = X * 10^{-12} \text{ } ^\circ\text{C}^{-3}$$

$$R_0 = \text{Resistance @ } t = 0,01 \text{ } ^\circ\text{C}$$

$$X = \text{Value}$$

Further specific parameters can be also configured for the already configured channel by pressing



the button

Based on the selected channel, the following screen appears:

GB

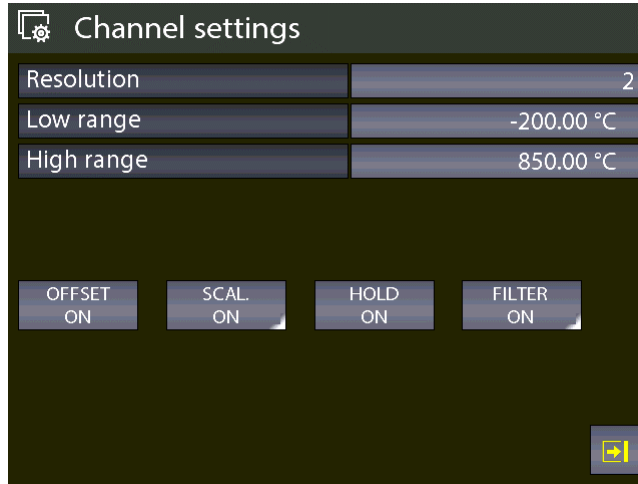

Figure 22 – Channel setting

Here, the resolution can be set by selecting the number of decimal digits and also the initial and final values of the calibration, the relationship between the configured channels as REF (REFerence) and DUT (Device Under Test).

This data will be used in the Report function.

### 6.3.2 Other assignments

#### 6.3.2.1 Pressure measurement

The following procedure illustrates the setting of Pascal ET, ET-P, ET/IS, ET-P/IS for pressure measurement. The particular channel is selected by pressing the channel letter (the background of the button changes in gray)

Then, press the button indicated with “Q” to assign the desired functional module:

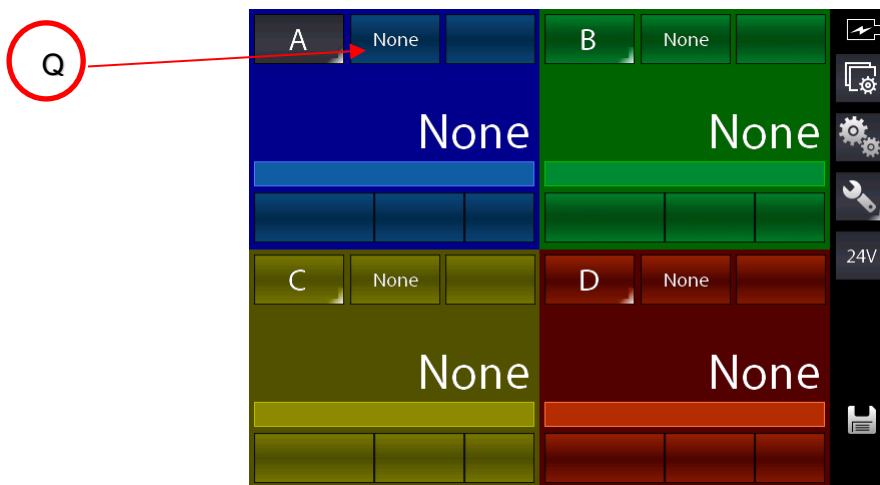

Figure 23 – Channel assign selection

The following screen appears:

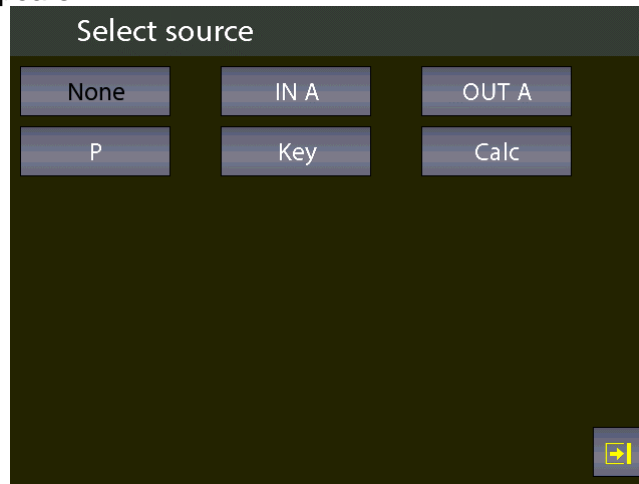

Figure 24 – Selecting the source “P”

Automatically the program shows the following screen and it remains in this position until the operator points out what type of parameter he desires to associate to a selected channel, for example to the Channel A. In this case press P for pressure.

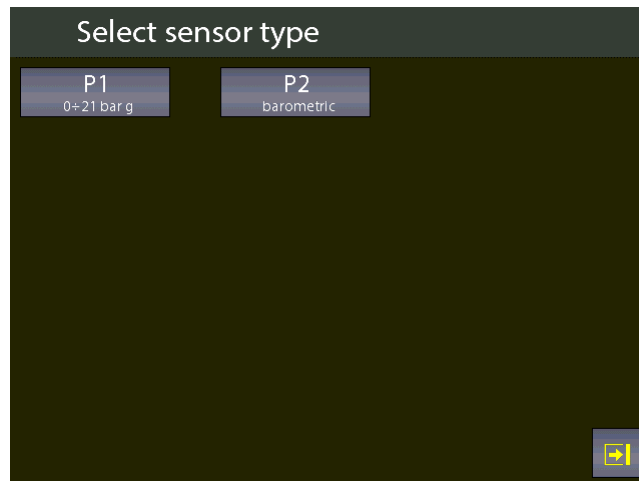

Figure 25 – Pressure parameter selection

The Pascal ET, ET-P, ET/IS, ET-P/IS can be equipped with up to two pressure modules and each of them can handle up to three pressure sensors, two internals and one external with standard accuracy.

**Note:** The shown list on the screen depends on the installed, mounted and connected number of sensors.

The sensor is identified by the measurement range and the measurement mode (g = gauge pressure or a = absolute pressure). This information is displayed under the writing PE-1 (first external sensor) or PE-2 (second external sensor). See the figure above as example.

When the sensor has been selected, the following screen appears:

GB



Figure 26 – Pressure sensor parameters selection

The pressure engineering unit can be changed by pressing the button indicated with “R” in the picture above.

The pressure engineering units available are:

Measure unit					
bar	mbar	ftH <sub>2</sub> O@4°C	inH <sub>2</sub> O@4°C	inHg@0°C	psf
psi	atm	torr	mH <sub>2</sub> O@4°C	cmH <sub>2</sub> O@4°C	mmH <sub>2</sub> O@4°C
mHg@0°C	cmHg@0°C	mmHg@0°C	kg/m <sup>2</sup> @g_std	kg/cm <sup>2</sup> @g_std	MPa
kPa	hPa	Pa			

Further specific parameters can be also configured for the already configured channel by pressing



the button

Based on the selected channel the the next screen shows the Span parameter (measuring range) and his resolution. For default the sensor has its maximum range equal to the measuring range (Span). If the Span can be redefined, or to be reduced, the same can be changed by using a numeric keyboard. The redefinition of the Span is used during a calibration for comparison where a relationship between a REF and a DUT channel has to be done.

The resolution can also be changed based on the desired number of decimal digits (related to the selected engineering unit):

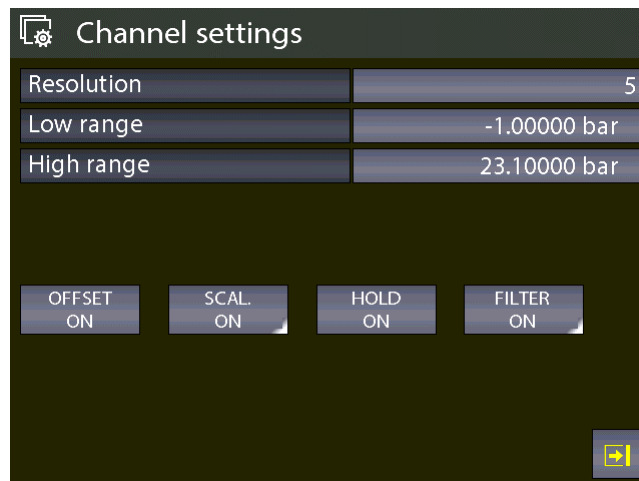

Figure 27 – Sensor range setup



### 6.3.2.2 Thermocouple signal measurement

The following procedure shows the setup of Pascal ET, ET-P, ET/IS, ET-P/IS for temperature signal measurement, for example, through a thermocouple connected to the IN (input) module. The particular channel is selected by pressing the channel letter (the background of the button changes in gray)

Then, press the button indicated with “Q” to assign the desired functional module:

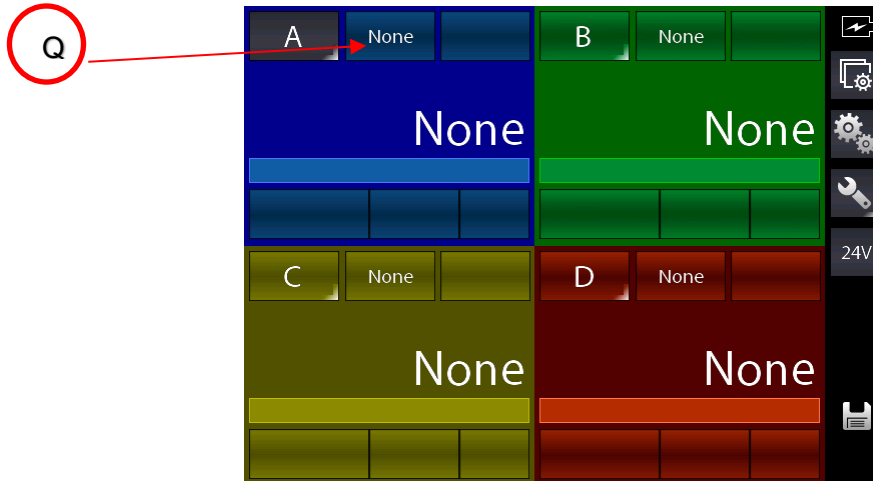

Figure 28 – Channel assign selection

The following screen appears:

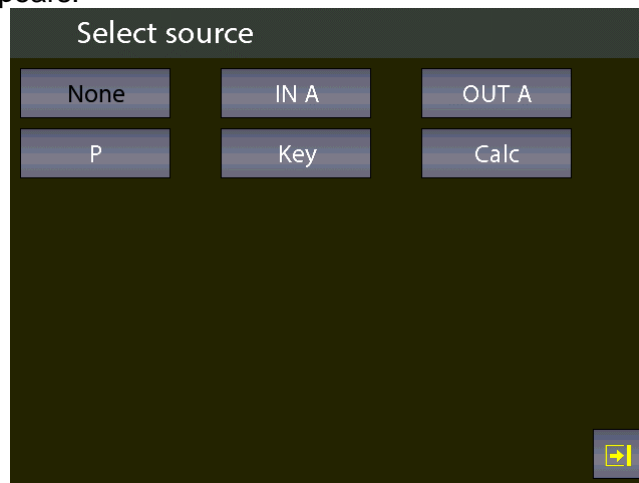

Figure 29 – Selecting source “IN A”

Automatically the program shows the following screen and it remains in this position until the operator points out what type of parameter he desires to associate to a selected channel, for example to the Channel A. In this case press the button “IN A” to measuring from the input.

The main screen changes as follows:

GB

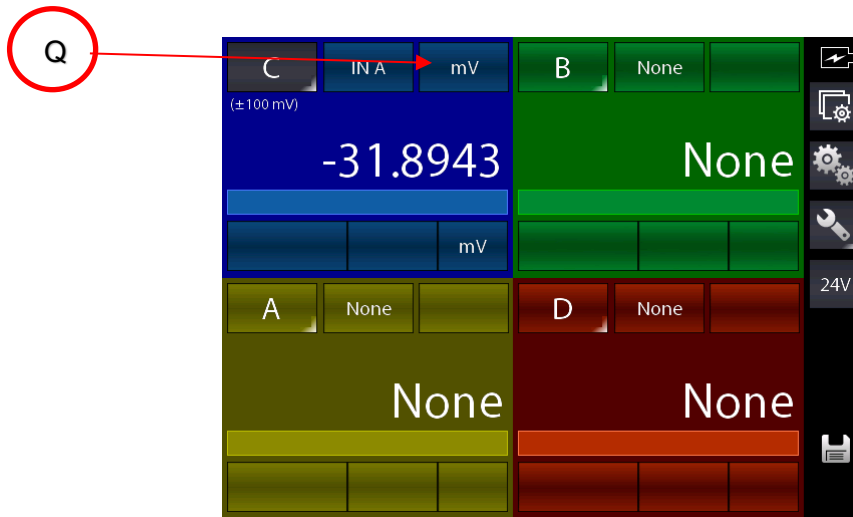

Figure 30 – “IN A” Selected

The calibrator is now set on the “IN A” module, and it select the last used unit for this module (in this case the last used unit was “mV”). Press the button indicated with “Q” to change the unit from mV to **Tc** and the following screen appears:

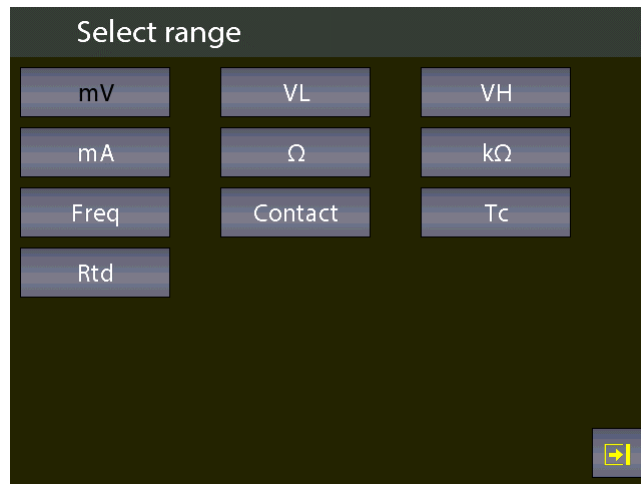

Figure 31 – Selecting the unit “Tc” for the module “IN A”

Press the button “Tc” and the main screen changes as follows:

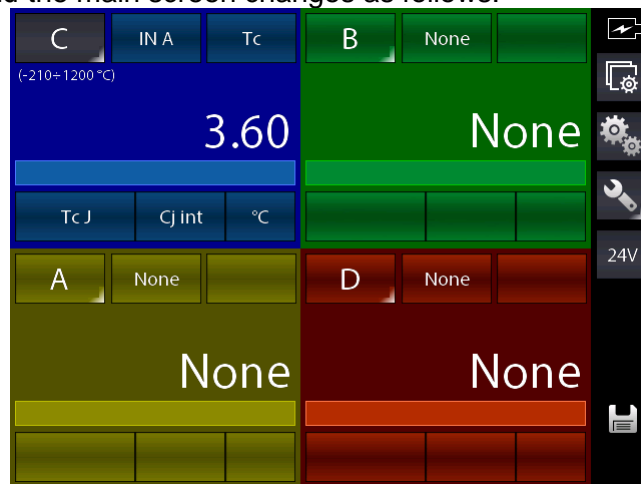

Figure 32 – Module “IN A” with unit “Tc” selected

The calibrator is now set for measuring “Tc”, and it select the last thermocouple type used (in this case the last thermocouple type used was Tc, Type J with internal cold junction (active) and temperature shown in °C.

Selecting “internal cold junction”, a Pt100 is directly connected to the TC input pins, measures the environmental temperature; whereas by selecting “external cold junction”, the temperature value must be inserted by using the keyboard.

Press “R” first in order to change the Cj type into external Cj type (E), then keep pressed the button “R” (a semi triangle symbol on the bottom right corner of the button “R” appears”:

GB

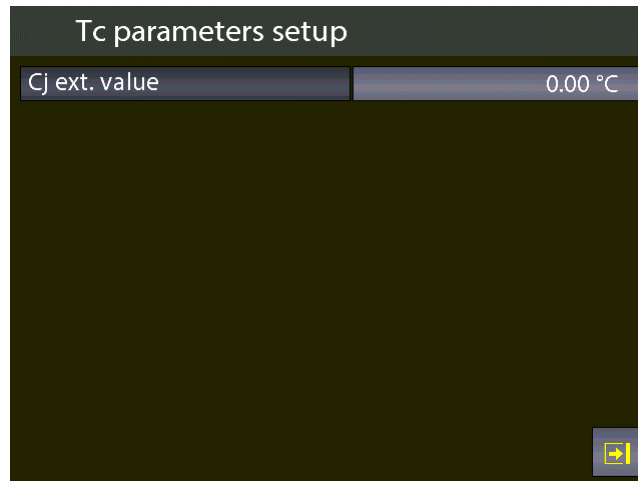

Figure 33 – Tc parameters selection: External Jc type (manual)

### 6.3.2.3 Electrical parameter measurement

The following procedure shows the settings of Pascal ET, ET-P, ET/IS, ET-P/IS for the electrical parameters measurement through the input module.

GB

The particular channel is selected by pressing the channel letter (the background of the button changes in gray)

Then, press the button indicated with “Q” to assign the desired functional module:

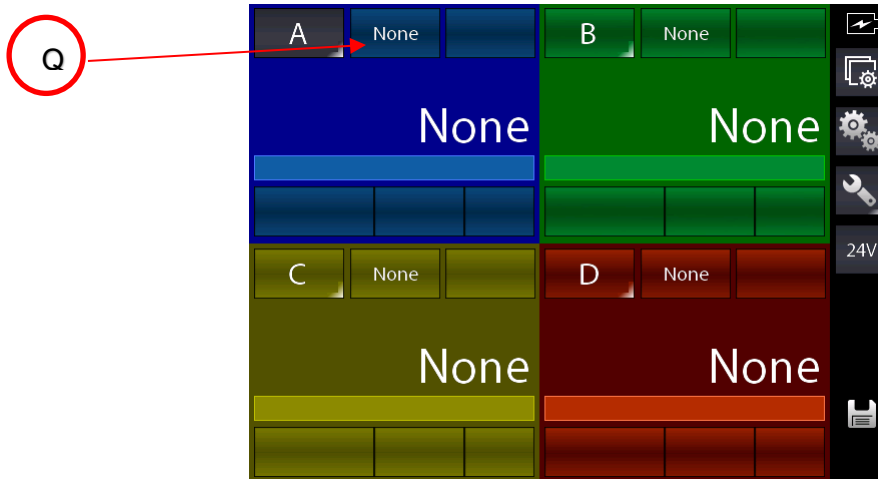

Figure 34 – Channel assign selection

The following screen appears:

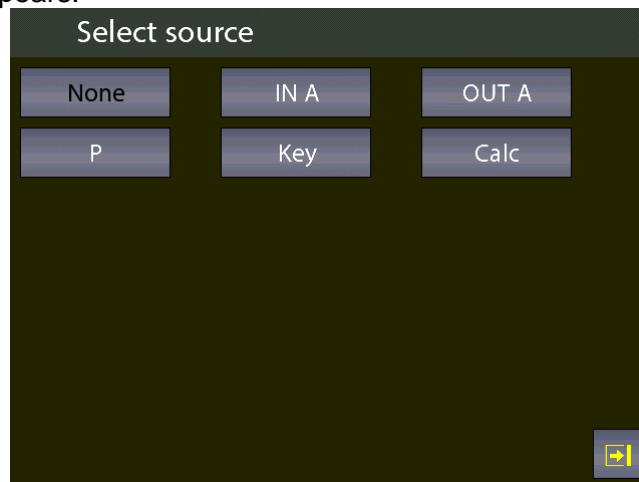

Figure 35 – Selecting the source “IN A”

Automatically the program shows the following screen and it remains in this position until the operator points out what type of parameter he desires to associate to a selected channel, for example to the Channel A. In this case press “IN A” for measuring from the input.

The main screen changes as follows:

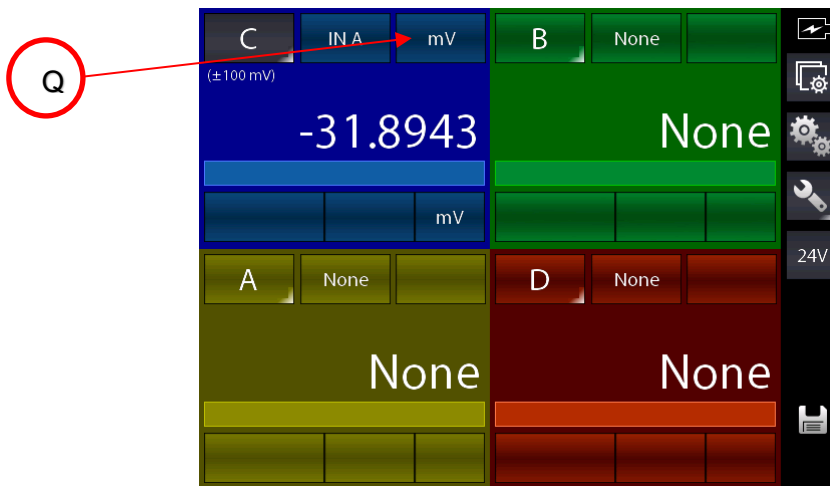

Figure 36 – Source “IN A” as first selection

GB

The calibrator is now set on the “IN A” module, and it select the last used unit for this module (in this case the last used unit was “mV”). Press the button indicated with “Q” to change the unit from mV to **Tc** and the following screen appears:

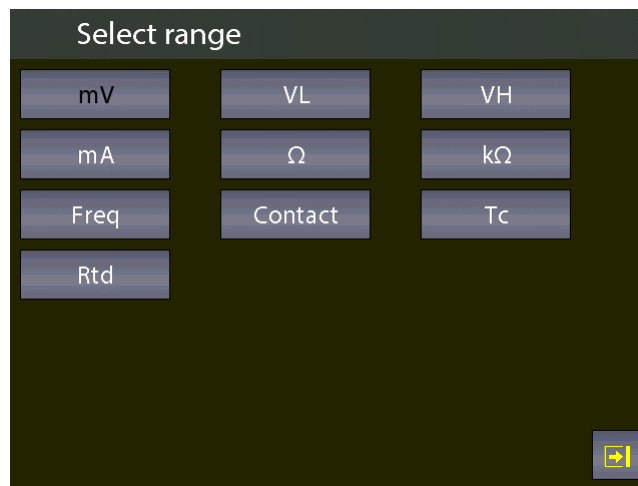

Figure 37 – Selecting “mA” unit for module “IN A”

By selecting the unit **mA** the following screen appears:

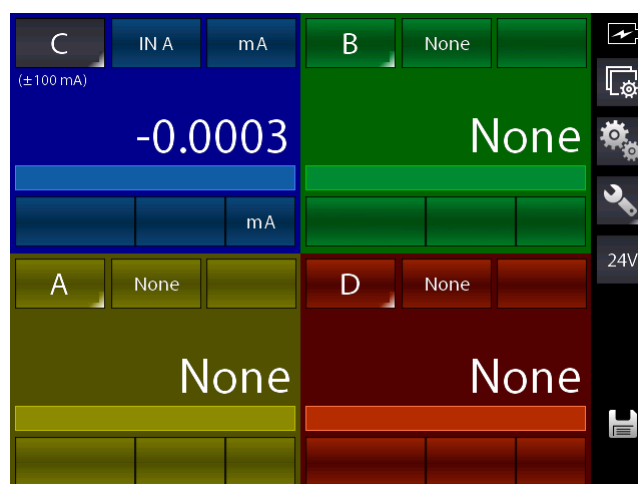

Figure 38 – Unit “mA” selected for module “IN A”

### 6.3.2.4 Temperature Simulation

The procedure for the temperature simulation assignment is similar to the measurement one as described previously, except for the step where the operator needs to select operative module by pressing the button indicated with “Q”:

GB

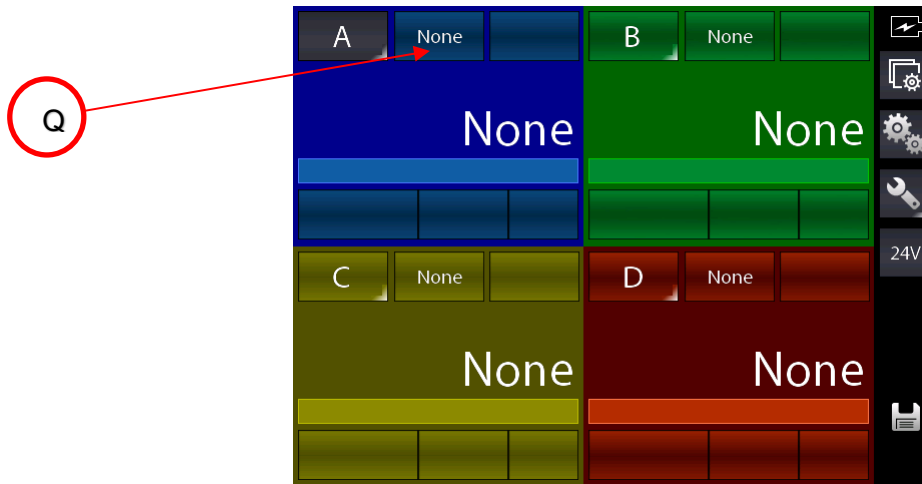

Figure 39 – Selecting channel assignment OUT A - mA

The next step is the selection of one of the output modules OUT A or OUT B (if present):

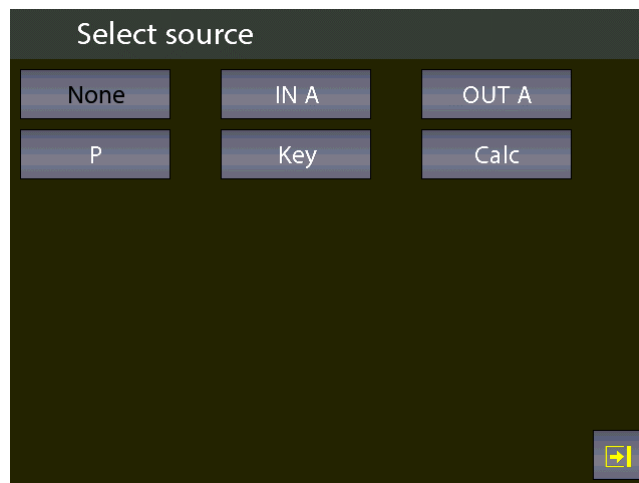

Figure 40 – Selecting generation module (OUT A or OUT B)

### 6.3.2.5 Electrical parameter generation

The procedure for the assignment of the generation of an electric parameter (for example mA) is similar to the electrical signal measurement one as described previously, except for the step where the operator needs to select operative module by pressing the button indicated with “Q”.

In this case the option OUT A or OUT B should be selected.

From the main screen, now the loop type must be selected between: passive (the calibrator Pascal supply the current loop) or active (current loop supplied externally):



Figure 41 – Setting the mA-loop generation

**6.3.2.6 Channel C or D – mathematic functions**

Channel C or D has an additional setting named CALC. This function enables to display on channel n. C or D a value, result of the combination of the values displayed in channel A and B. To access, select the channel C, or D, then the button for selecting the source:

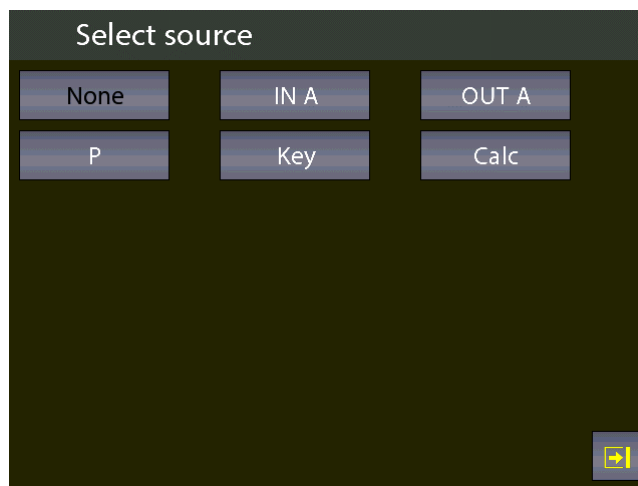

Figure 42 – Selecting module Calc

Pressing CALC the followings screen is displayed:

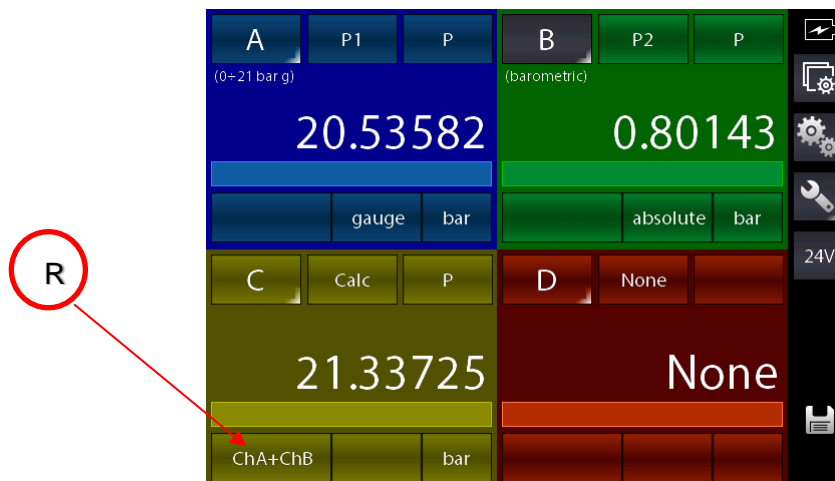

Figure 43 – Selecting assignment of channel Calc

The calibrator is now set for the module CALC and it preset the last used calculation type for this module (in this case the last used calculation type was ChA+ChB).

GB

Press the button indicated with “R” in the picture above to select another calculation type.

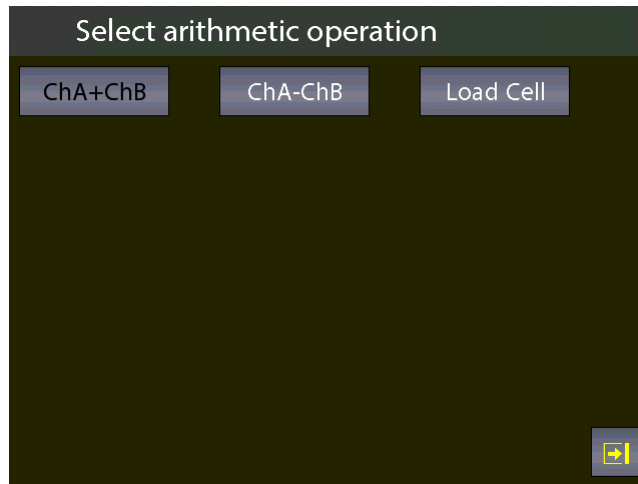

Figure 44 – Types of calculation

Here you can find:

- CHA + CHB** channel 4 or C displays the total value of the values displayed on channel A and B
- CHA - CHB** channel 4 displays the difference value of the values displayed on channel A and B
- Cell Load** channel 4 or D4 displays the ratio mV/V of the load cells

CHA+CHB and CHA-CHB functions can be used only if channel A and B are set with the same values: same engineering unit, same number of digits, no channel assigned with error indication. Otherwise the channel 4 will be displayed as:

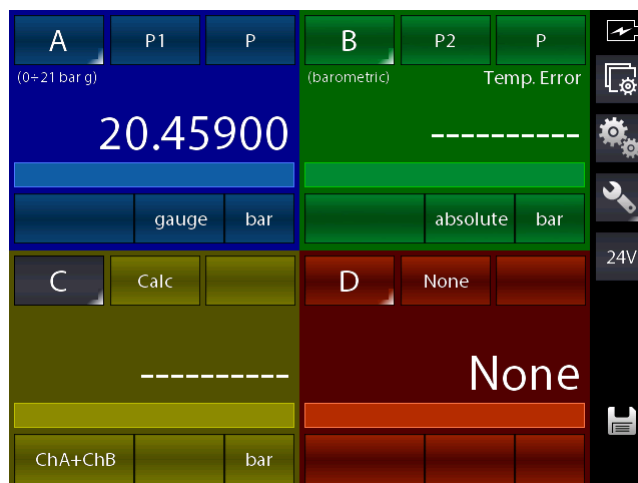

Figure 45 - Calculation non possible for the Channel 4



For the Cell Load, the channel 4C or D can calculate the result coming from a load cell connected as per the below scheme:

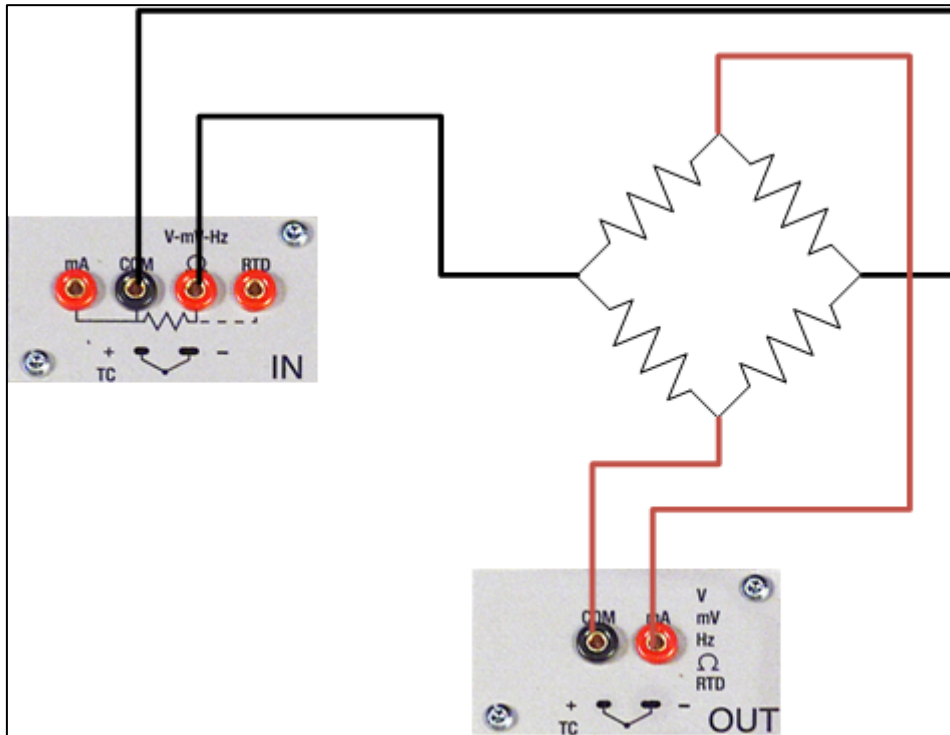

Figure 46 – Cell Load connection

Calculation is possible only when channel A is assigned for mV measurement (bridge signal) and channel B is assigned for V generation, range 0÷20 V (bridge supply). Moreover channel A should not be set in error mode.

GB

In this case, below what will be displayed:

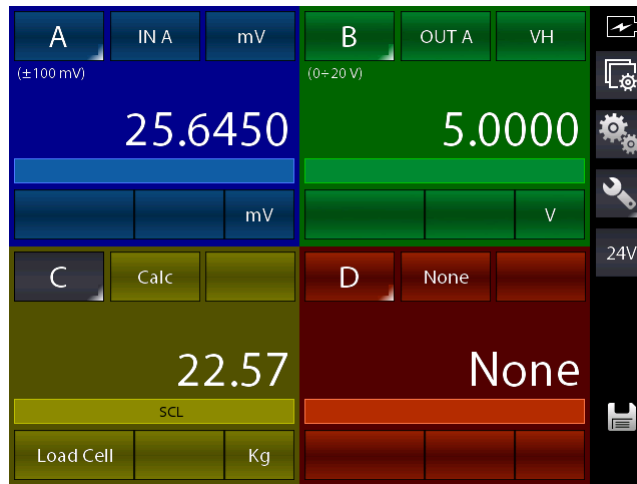



Figure 47 – Cell Load calculation

Pascal ET, ET-P, ET/IS, ET-P/IS allows to manage the sensitivity of the load cell from 0 mV/V up to 9.99999 mV/V.

Moreover, on channel 4C or D, the SCALING function can be assigned through the menu

CHANNEL SETTINGS (button ) in order to display an engineering unit more appropriate (for example Kg or a pressure unit).

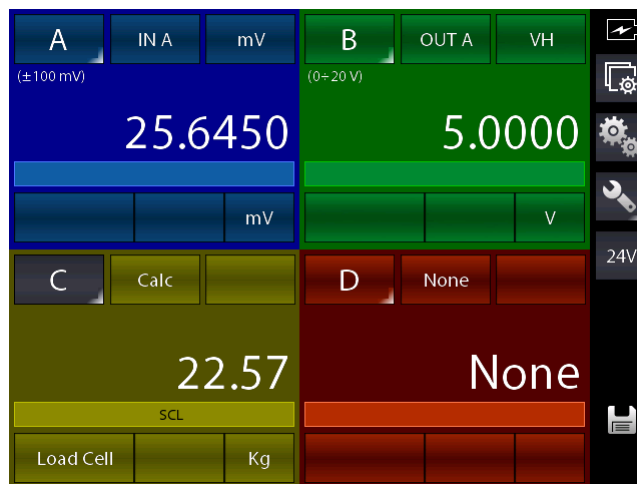

Figure 48 – Cell Load calculation with Scaling function active

### 6.3.2.7 HART channel assignment

To select the channel press on one of the four large displays, then press CHANNEL. Once menu is displayed press ASSIGN. Procedure is shown below:

The particular channel is selected by pressing the channel letter (the background of the button changes in gray)

Then, press the button indicated with “Q” to assign the desired functional module:

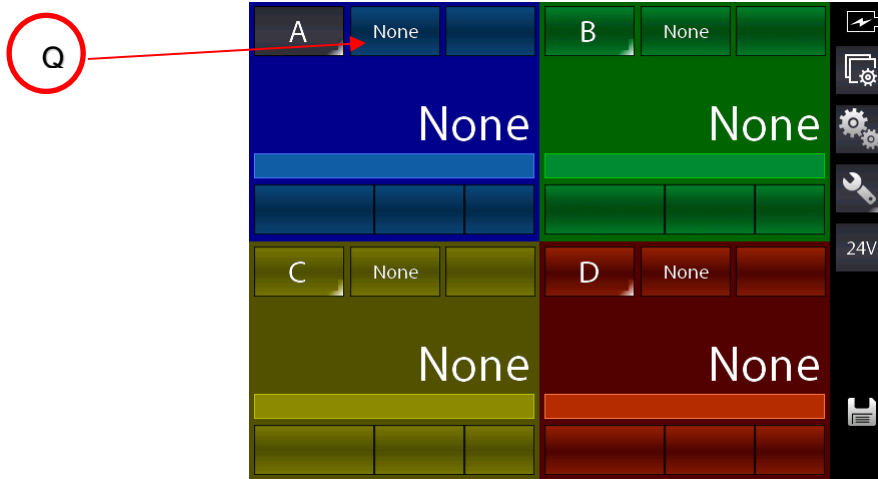

Figure 49 – HART Channel assign selection

The following screen appears:

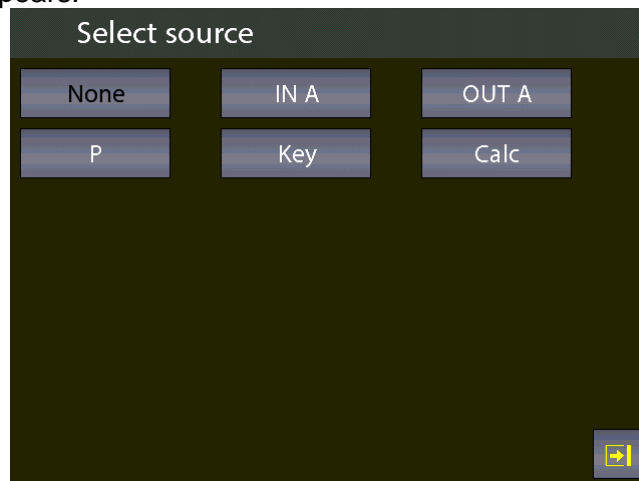

Figure 50 – Selecting the source “HART”

Select HART for HART measurement:

GB

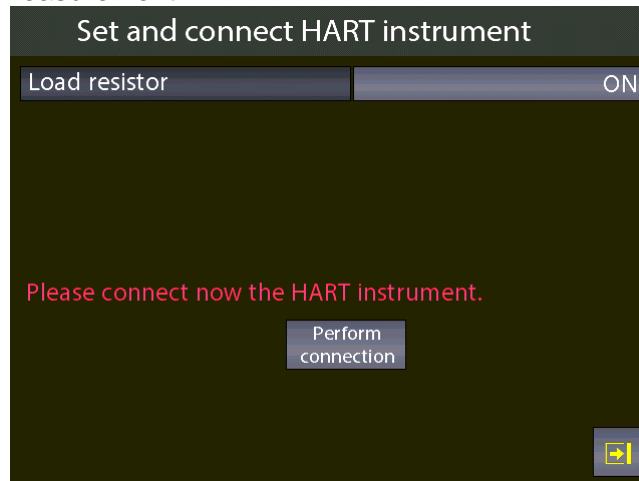

Figure 51 – Connecting a HART device

Here the user can choose if enable the internal module 250Ω resistor (ON or OFF), needful for HART communication (it can be connected externally or can be supplied by the calibrator).

Before pressing “**Perform connection**” be sure to already make the proper connections to the HART instrument

Press “**Perform connection**” and, after few seconds, if no error is shown the following main screen appears:

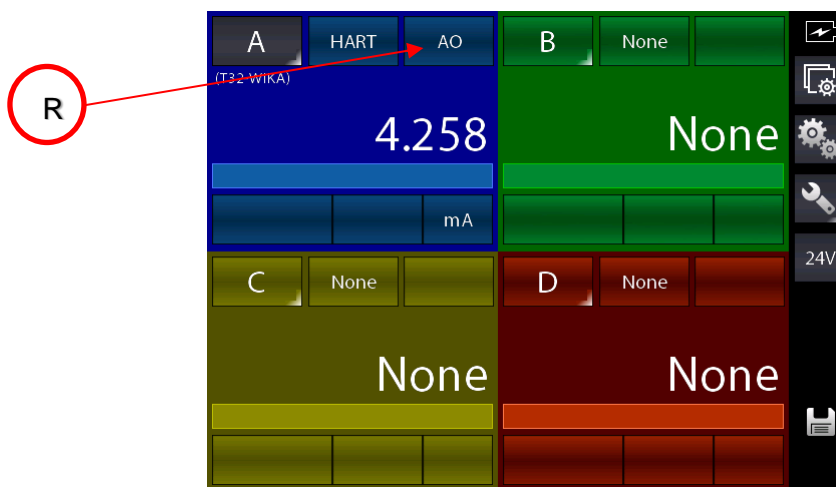

Figure 52 –HART channel assigned

The main screen shows the HART AO (Analogic Output) value.

Press the button indicated with “R” to display the PV (primary variable) parameter.

Here the user has the possibility to change some HART parameters:

- Select the channel with active HART communication (in this case the channel A)
- Push the button Channel Settings  to open the following screen:

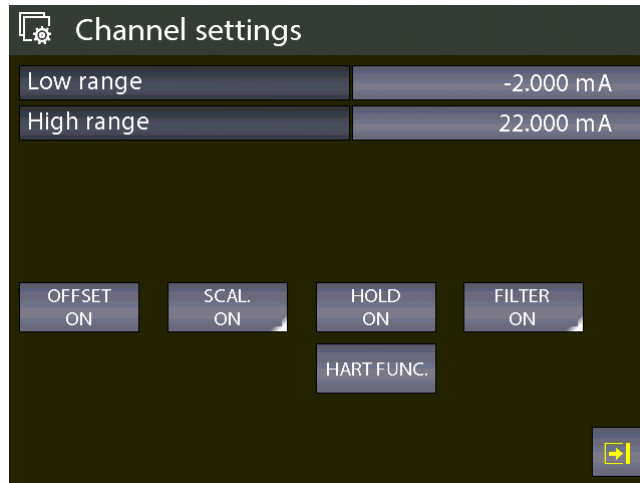

Figure 53 – Setting the HART channel

Push the button “HART FUNC” and the following screen appears:

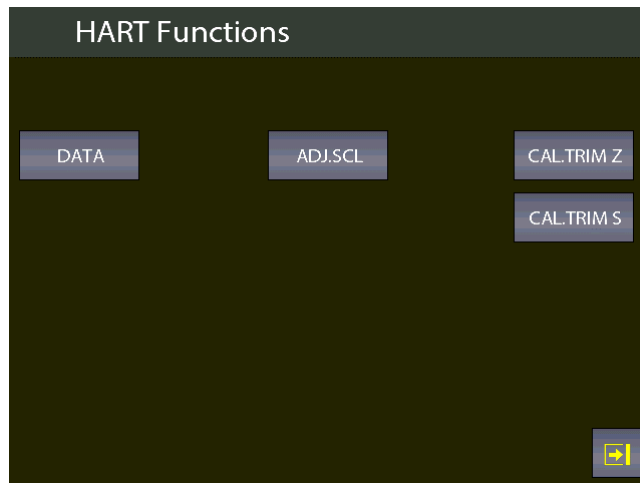

Figure 54 – HART function screen

Push the button “DATA” to display the HART data:

HART data	
Tag:	T32-WIKA
Descriptor:	DEMO UNIV
S/N	848823
Manufacturer	Wika
PV Decimals num.:	5
Low scale value	-203.32998 °C
High scale value	863.00000 °C
PV LRV:	23.15973 °C
PV URV:	110.00000 °C

Figure 55 – HART data display

Here the user has the possibility to change some parameter by pushing on the value on the right side of the screen (the ones shown with ‘:’ the arrows at the bottom of the screen display further parameters).

GB

They changeable parameters can be: TAG, DESCRIPTOR, PV decimals units, PV LRV and PV URV.

Press, for example, the button for the TAG value: the following screen appears:

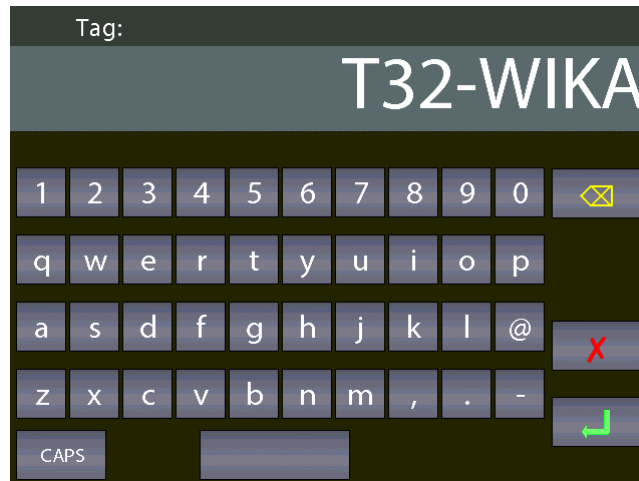

If desired delete all the characters with backspace and insert the desired. After press ENTER to store the parameter inside the HART transmitter; the Pascal will return to the previous display.

**IMPORTANT NOTE: HART requires that all the characters must be in upper case in order to be properly stored.**

### 6.3.2.8 HART trimmer calibration

When the HART transmitter needs to be recalibrated or adjusted the HART screen shows two types of possibilities:

- ADJ.SCL
- CAL.TRIM (Z,S)

With CAL.TRIM user can correct the analog mA generation, of the HART transmitter, referred to the digital AO value displayed if the output DAC goes out of tolerance.

Zero and Span needs to be corrected.

If the user wants to recalibrate the Trim. an INPUT mA measurement channel has to configured as REF channel. In addition, the loop wiring needs to flow to the IN mA terminals.

If no REF mA Input channel is configured first an error will be shown.

From the following screen:

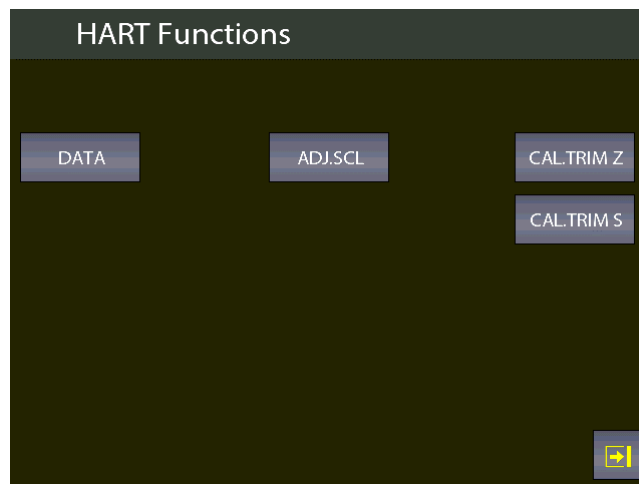

Select, for example, the “CAL.TRIM S” button:



The HART instrument is put in fixed mode generation (4 or 20 mA) and the REF channel is measuring the true analog mA generation. To re-align to the correct 20 mA (or 4 mA) generation press “CALIBR.” button.

If needed follow the same procedure for “Zero Trim”.

### 6.3.2.9 HART scale adjust

ADJ.SCL permits to align the range of PV to the Lower and Upper mA generation values. The Lower value of PV is the value at which the transmitter will generate the 4 mA nominal value, and the Upper value is the value at which the transmitter will generate the 20 mA nominal value. Here is described the “automated” procedure that permits to align in “real-time” these values. The user can also change them manually in the “HART data” page as seen before. If the user wants to adjust the scale a channel of the same input type of the transmitter has to be configured as REF channel. If no REF channel is configured first an error will be shown.

Press ADJ.SCL menu and the following is shown (assuming that we are using a Pt100 transmitter, e REF simulation Pt100 channel is configured as Channel B):



Set the REF Channel to the desired value that permits to output by the transmitter the 4mA value (example 20°C). When the value is stable press ADJ. LRV button.

Now set the REF Channel to the desired value that permits to output the transmitter the 20mA value (example 150°C). When the value is stable press ADJ. URV button.

Now the transmitter will generate 4 and 20 mA between 20 °C – 150 °C.



## 6.4 Setting channel, function, instrument

All settings can be performed by using the first three buttons on the right side of the main screen from the top to the bottom:

GB

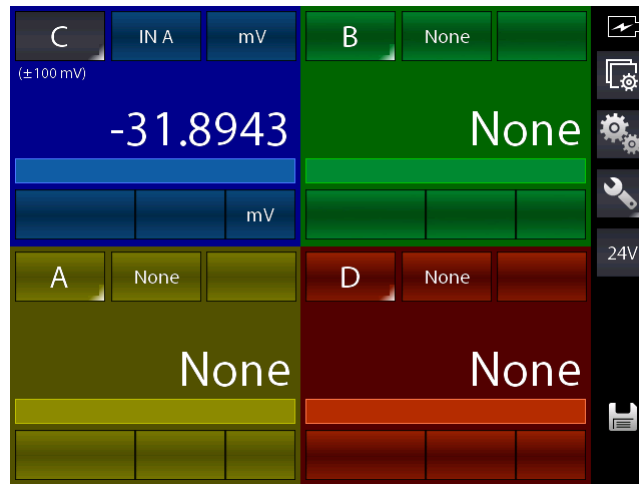

Channel setting



Function setting



Instrument setting (press and key pressed for some seconds this key to enter the status page)

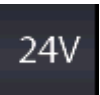

Switching button: it enable/disable the 24 V DC current supply for external instrumentation

### 6.4.1 Channel setting

A dedicated screen allows to configure the instrument channel: this screen contains dynamic elements, so they can differ depending on the module of the channel. If, for example, the channel is configured for thermoresistance measurements, by pressing the button “Chanel setting” the screen could be show the following parameters:

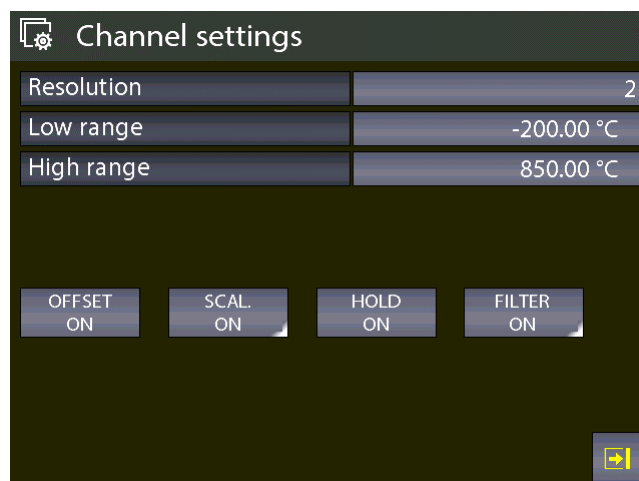

Figure 56 – “IN” Channel setting

GB

It consists of:

<b>SCALING ON/OFF</b>	to enable/disable the scale function and display it with a different engineering unit. The parameters of the proportional value can be shown by keeping pressed this button.
<b>FILTER ON/OFF</b>	to enable/disable the user noise filter on the signal. The parameters of the filter value can be shown by keeping pressed this button.
<b>HOLD. ON</b>	to hold the last display (HOLD function)
<b>OFFSET. ON</b>	to set the zero for the measurement
<b>RESOLUTION</b>	to set the number of decimal digits to display
<b>LOW/HIGH RANGE</b>	to set the reference values of the low and high ranges when channel mode REF and DUT are uses

By entering the settings for an output channel, the same screen shows other functions for that channel:

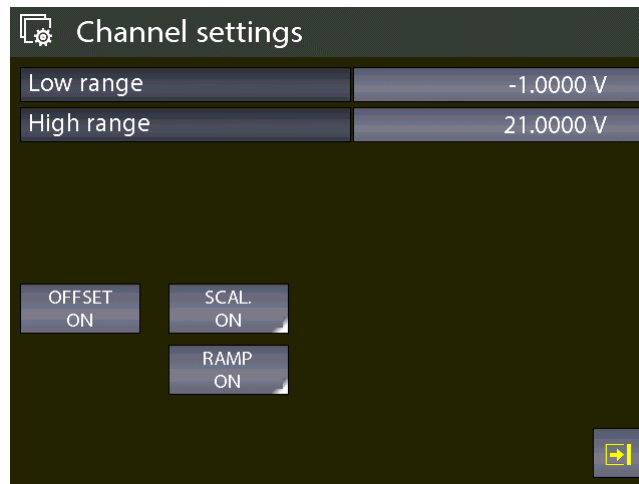

Figure 57 – Setting output channel parameters

The RAMP function can be enabled as output channel (generation). It works in the following way:

The RAMP button appears for the selected channel if it has been assigned to an output board.

With this function the user can program a ramp by automatically shifting the generation value in configurable steps.

If both the 2 generation board are installed, and they are been assigned to two different channels, a different ramp for each output can be programmed.

The programmable ramp follows the following profile:

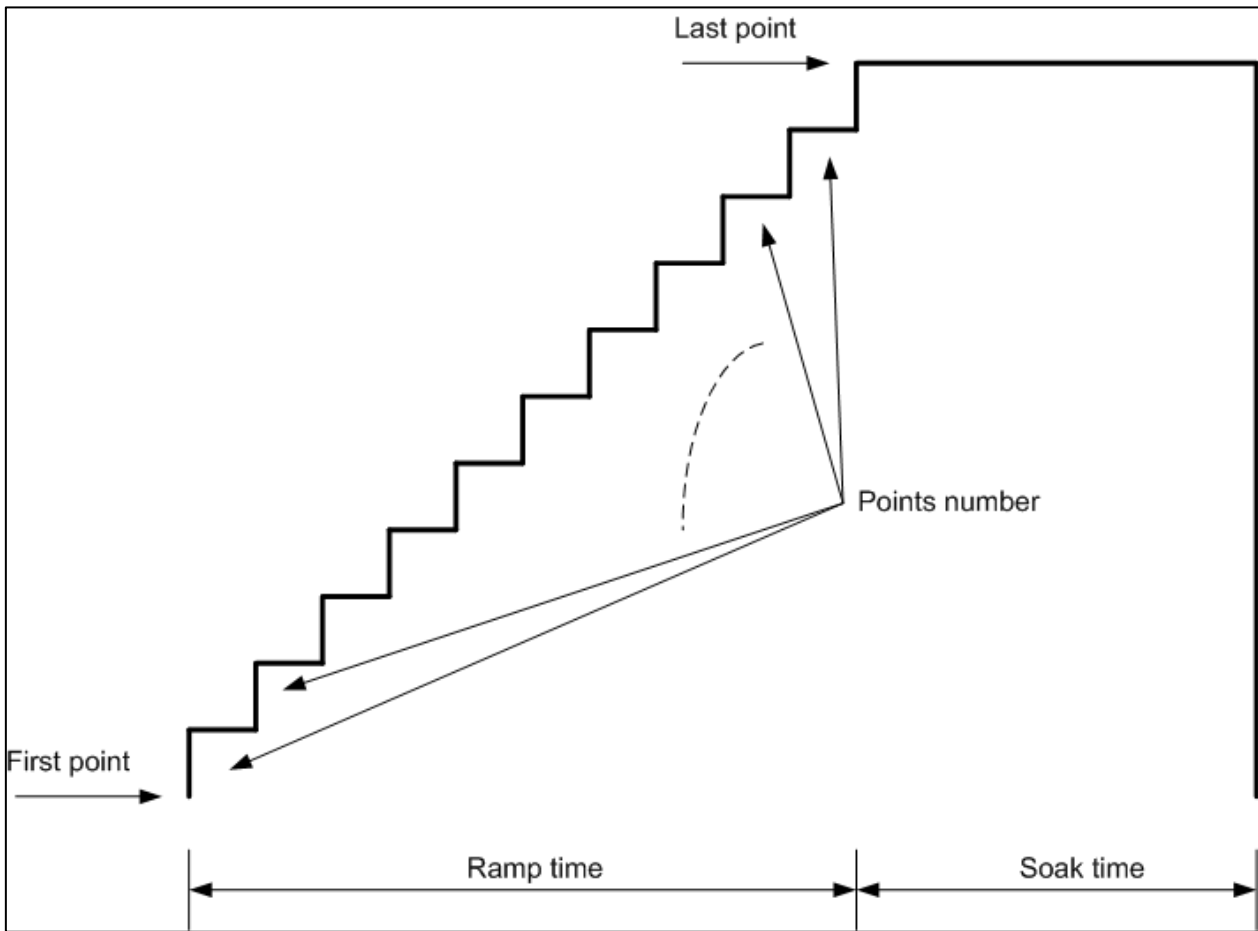

Figure 58 – Ramp profile

Keep pressed the button “RAMP ON” to set the ramp parameters:

Ramp parameters setup	
Step mode	auto-up
Cycles num.	2
N. Points	11
First point	0.0000 V
Last point	10.0000 V
Ramp time	00:00:20
Soak time	00:00:05

Figure 59 – Setting ramp parameters

The screen above shows a ramp with low range of 0 V, the value reach the high range of 10 V in 11 steps and after 20 seconds, and the ramp runs for 2 cycles.  
 Go back to the previous screen and press the button “RAMP ON” shortly to run the ramp function: the calibrator will show the main screen and on the output channel the indication “ramp” will appears (ramp active on channel B).

GB



Figure 60 – Ramp function active



More Information about the Channel Menu is available in chapter 6.6

### 6.4.2 Functions setting

This screen is used to setting the calibrator function: The screen is as follows:

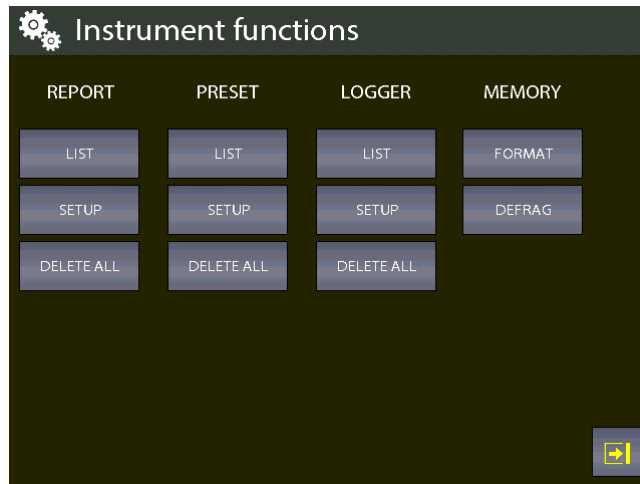

Figure 61 – Functions setting

Here the user can set different functions grouped by:

- REPORT
- PRESET
- LOGGER
- MEMORY

#### REPORT section:

This section is intended for the reports management.



For detailed information see chapter 6.7

**PRESET** section:

This section is intended for the presets management.



For detailed information see chapter 6.7

**LOGGER** section:

This section is intended for the datalogger management.



For detailed information see chapter 6.8

**MEMORY** section:

The data regarding the report, the datalogger and the presets are stored in the internal memory of the instrument. It is a virtual memory, the same as the files saved on a computer.

The MEMORY section provides 2 different selections:

**FORMAT:** it deletes the memory completely and it is reset to the company default. This option will delete ALL the above mentioned data, but a confirmation message will appear before executing the command.

**DEFRAG:** This function can be useful if a lot of data are saved and deleted frequently. In this case some not used black spaces could be created in the memory and a message for insufficient space for storing new data could be displayed. The Defrag function can be used to recover that not used space; the saved data WILL NOT be deleted but a certain time should be necessary to complete the process.

**6.4.3 Instrument setting**

This menu enables to see and change the settings of the instrument.

Setup instrument	
Date	10/04/17
Time	12:01:18
Date format	dd/mm/yy
Language	english
Serial baudrate	460800
AutoPoweroff time	0 min
Lock scr. PowerON	OFF
F Key assign	Not assigned

Figure 62 – Instrument setting screen

### 6.4.3.1 Setting the “F” key of the keyboard

The last function displayed in the picture above can be set.

Push the button at the right side close to the field “F key assign”.

GB

Each option is active only from the main screen, if the calibration is not currently performing a report or an HART adjustment.

The following screen appears:

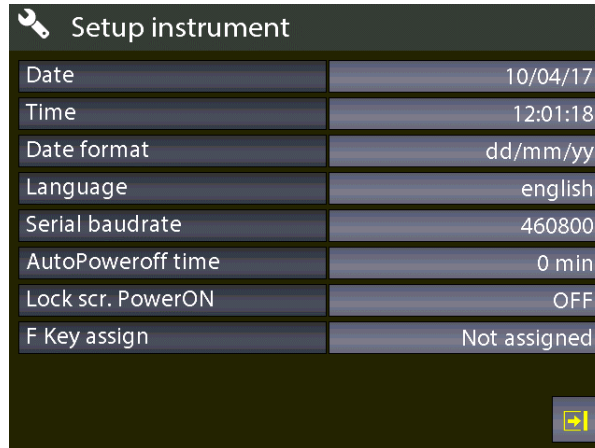

Figure 63 – Setting the “F” key

The available options are:



Figure 64 – F Key assignment

**Hold All ON/OFF:** press the F key to enable/disable the HOLD function on all active measuring channels.

**Recall Report list:** press the F key load the list of the saved reports

**Recall Preset list:** press the F key load the list of the saved presets

The status page for the calibration can be displayed by pressing the button  on the main screen: the following information are displayed:

Instrument status page	
Model:	PASCAL100/IS-IOHP2
S/N	65034
Ver. MASTER:	4.00.03
Ver. KERNEL:	1.00.03
Ver. LCD:	1.00.03
RH-T-P S/N:	1
Battery voltage:	5.44 V
Usage time:	00000d:33h:01m

Figure 65 – Instrument status page display

## 6.5 Channel settings

For setting the channel the following dedicated screen appears:

Channel settings	
Resolution	2
Low range	-200.00 °C
High range	850.00 °C
<div style="display: flex; justify-content: space-around; margin-top: 10px;"> <span>OFFSET ON</span> <span>SCAL ON</span> <span>HOLD ON</span> <span>FILTER ON</span> </div>	

Figure 66 – Channel setting screen

### 6.5.1 Offset On – Offset Off

The Offset On/Off button is used to zeroing or restoring the measure/display of the actual active channel.

Press the button Offset on to zeroing the measure (the button shows the indication “Offset off”); if the button is clicked again the Offset Off function is activated (the button shows the indication “Offset on”).

The text “OFS” on the blue bar of the main screen indicates that the function is activated.



Figure 67 – Offset function activated

### 6.5.2 Scaling

The engineering unit can be changed by the user by using the Scaling function.

By pressing the Scaling button the following information are available:

- Low scaling: min. value of the signal and reading scale (i.e. 0 Kg @ 0 bar)
- High scaling: max. value of the signal and reading scale (i.e. 10 Kg @ 5 bar)
- Eng. Unit Scl: customized engineering unit of the measuring signal
- Decimals num.: number of decimal digits requested
- Transfer functi.: linear, square root, square

Scaling parameters setup	
Low Scl	0.000 kg
	0.00000 bar
High Scl	10.000 kg
	5.00000 bar
Eng. unit Scl	kg
Decimals num.	3
Transfer. funct.	linear

Figure 68 – Scaling parameters setting

After setting the parameters go back to the previous screen by shorty pressing the button Scaling ON.

The main screen now displays the active function by showing the text "SCL" on the blue bar. The measuring value with the new unit is displayed with big numbers, and the actual measuring value is displayed with small numbers, close the indication "Signal". The following screen shows two channels and the first one displays the active Scaling function:





Figure 69 – Channel with active Scaling function

### 6.5.3 Hold On – Hold Off

The HOLD ON-HOLD OFF button is used to freeze what displayed for the selected channel. Press HOLD ON to hold the values: HOLD OFF will appear. Press it to unlock the channel. HOLD ON will appear again

HOLD on the display means that the values are hold. See below:



Figure 70 – Channel with HOLD enabled

### 6.5.4 Modification of the generation/simulation value

The generated/simulated value of an Output card or KEY can be modified from the main screen directly, by pressing the value:

GB



Figure 71 – Generation / simulation value modifying

By pressing the value indicated on the picture above you can select the value of the signals within the limits specified during the assignment (clearly indicated under “min” e “Max” on the left side) with the help of a keyboard:

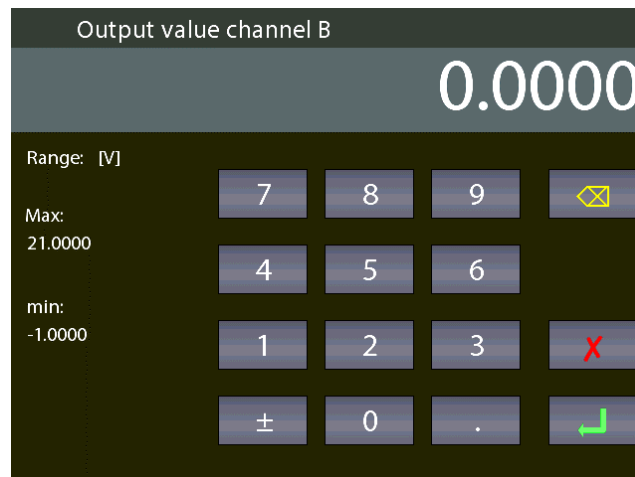

Figure 72 – Modification of generation/simulation value

## 6.6 Report

To create a report one channel has to be set as REF (*Reference*) and another one as DUT (*Device Under Test*): reference signal and direct measurement (or manual input by keyboard) are required. For the REFERENCE: remember to set the range equivalent to the one of the DUT. When the channel is assigned as reference, the symbol REF will appear.

For the DUT: remember to define the max error and the declaration. A bargraph will be displayed on the DUT channel. When the channel is device under test, the symbol DUT will appear.

Options are available on the screen for the Functions Setting (see paragraph 6.5.2.):

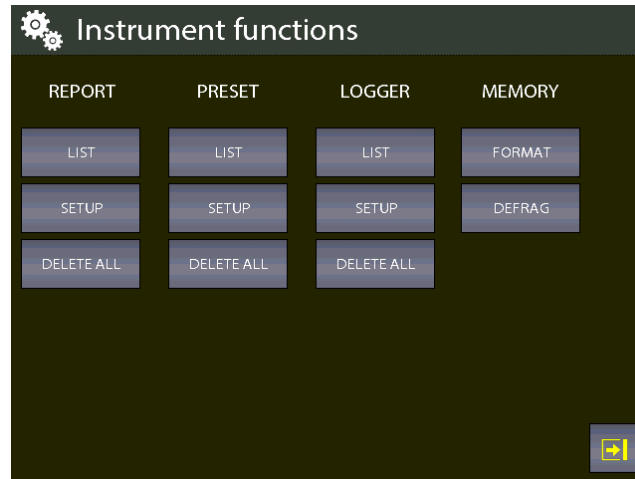

Figure 73 – Functions setting

On the REPORT column the available options are:

**LIST** View Reports  
**SETUP** Reports setup  
**DELETE ALL** Deletes all the Reports

On the PRESET column the available options are:

**LIST** View preset list  
**SETUP** Preset set up  
**DELETE ALL** Delete all the presets

Press SETUP to create a new Report.  
 Info required are:

Report name  
 DUT model (Device Under Test)  
 DUT Serial Number (Device Under Test)  
 Operator  
 Job Number  
 Found Left  
 Up Down  
 N. Points

A standard Report configuration for the calibration of a pressure transmitter 0-1 bar range is available here below

GB

Report Setup	
Report Name	rptalpha
Dut Model	pressure transm.
Dut Serial Number	178FE
Operator	adg
Job Number	ce5mk
Dry Block type	None
Found Left	As found As left
Up Down	Up Down
N. Points	10
<input type="button" value="STORE"/> <input type="button" value="▼"/> <input type="button" value="↔"/>	

Figure 74 – Report setup, page 1

Report Setup	
Found Left	As found As left
Up Down	Up Down
N. Points	10
First point	0.00000 bar
Last point	1.00000 bar
<input type="button" value="STORE"/> <input type="button" value="▲"/> <input type="button" value="↔"/>	

Figure 75 – Report setup, page 2

Once completed Press STORE per memorize the data.  
The following screen will appear:

Warning

Store report setup

Do you want store report setup?

Figure 76 – Store Report request

Press YES to store the report set up and then press again yes to run the report.

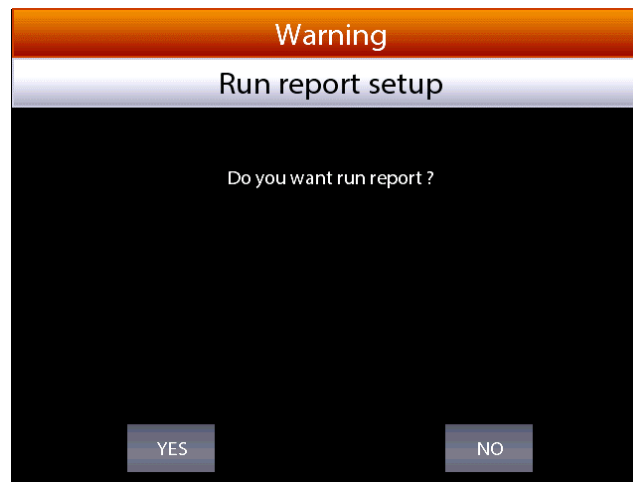

Figure 77 – Report run request

The main screen will be displayed as per below:



Figure 78 – Report running display

On the bottom, the report name (rpt1), the calibration point (1 of 20) and the related reference value (0.00000) will be shown. Press STORE to store the first calibration point: the switch to the second point is done automatically (pnt 2 will be shown), and so on for all the predefined calibration points. Pay attention to the bargraph in the DUT display: check if point is inside or outside the limit specified during the DUT assignment.

Once the calibration cycle is defined, the generation of an electrical signal is done automatically. For the pressure, instead, the operator has to reach the required pressure values using the manual pump and the fine adjustment.

During the configuration process the operator can name the report: the same can be recalled when the same procedure is required.

In any moment the operator can stop the calibration pressing ABORT.

To make the zero on the reference channel REF, press OFFSET ON before storing the first calibration point: this function is displayed as OFS on the channel display, under the measurement value.

Press again OFFSET OFF to come back to the original configuration: OFS will disappear.

Once the last calibration point is done, press STORE (or ABORT): the Report will end automatically and the display will go back to its original configuration.

On the screen for the Functions Setting (see paragraph 6.5.2.) press LIST to view the stored reports:

GB

Report list		
cc	01/01/00	1
rpt1	14/04/17	2
rptalpha	14/04/17	3
tt	13/01/17	4
tt2	13/01/17	5
ii	13/01/17	6
jj	VOID	7
sw2	01/01/00	8
sw5	01/01/00	9

Figure 79 – Display Report list

The above picture shows the list of the existing report: name and status are displayed. Under the status, the writing AS FOUND is displayed when the calibration data refers to a calibration process done on an instrument without any adjustment: when a date is available this means that calibration process is complete (AS FOUND AS LEFT). If the report has never been run, VOID will be displayed next to the name.

Press the arrows to move the cursor up and down to select the report, press the button with light grey background to visualize the information available in the report.

To cancel the reports press and keep pressed the button with light grey background: a confirmation is required by the operator before proceeding.

Selecting the area with light grey background next to the report name, the SETUP of the report will be displayed:

View Report setup		rptalpha	
<b>Channel B</b>			
ROLE:	REF PASCAL100/IS	SN:65034	
CONNCT:	P1	RANGE:	0÷21 bar g
LOW:	0.00000 bar	HIGH:	1.00000 bar
<b>Channel A</b>			
ROLE:	DUT pressure transm. SN:178FE		
CONNCT:	IN A	RANGE:	±100 mA
LOW:	4.0000 mA	HIGH:	20.0000 mA
Max Err.:	0.100 %	Error decl.:	% of span
REF-DUT relation:	Ilinear		
<b>Channel C</b>			
CONNCT:	None	RANGE:	
LOW:	0	HIGH:	0
<b>Channel D</b>			
CONNCT:	None	RANGE:	
LOW:	0	HIGH:	0
RUN		POINTS	
RESULT		NEW RPT	

Figure 80 – Display Report setup

Pressing POINTS, the list of the calibration points will be shown:

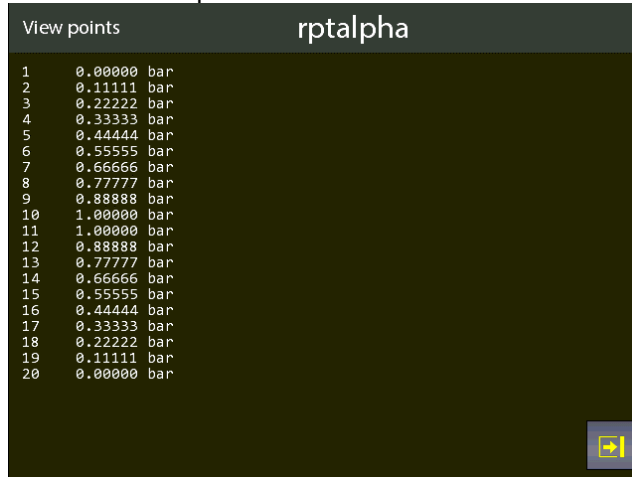

Figure 81 – Display test points Report

Pressing RESULT, the calibration results are shown:



← Scrolling menu

Figure 82 – Display Report results

The buttons on the bottom of the screens allow to access further points (if present): “As found”, “As left”, “Up”, “Down”, will appear to enable to see the calibration results related to the different calibration stages.

“As found”, (calibration points before any adjustment on the DUT) “As left” (calibration points after the adjustment on the DUT has been carried out), “Up” (calibration points going up), “Down” (calibration points going down).

On the screen for the Functions Setting (see paragraph 6.5.2.) press DELETE ALL to delete all the reports in the memory.

**Note:** a confirmation message will appear before deleting all data

### 6.6.1 Report of Tc/Rtd with dry well calibrator or dry block management

The Pascal calibrator allows to create reports for Thermocouples/Thermoresistances by using a dry well calibrator and by automatically manage the temperature points. With the serial interface the Pascal calibrator is able to connect to some dry well calibrators and automatically set the temperature value e and detect the reached stability in order to automatically store the temperature points and then run the test autonomously.

The Pascal calibrator can manage the following dry well calibrators:

- All models of the Scandura BL-x Series
- All models of the WIKA CTD-9100-x Series
- WIKA model CTD-9100-1100
- Giussani's dry well calibrators Pyros Series

The models of the WIKA CTD-9100-x Series require an adapter kit for the conversion from RS-232 to RS-485. The order code for the kit is: 241113.

NOTE: for some dry well calibrators a switching on safety condition could prevent the automatic setting of a set point. In this case the operator must disable this feature. Please read the user manual supplied with the dry well calibrator for further details.

For managing of this report the Pascal calibrator also must be equipped with almost 2 IN interfaces, where one interface must be connected to a reference thermometer (RED) and the second one to the device under test (DST), both used into the same well dry calibrator.



An RTD or a thermocouple can be used for both the reference thermometer (REF) and the device under test (DST):



Example:



Press **REPORT** e set it by using the command **SETUPRPT**:

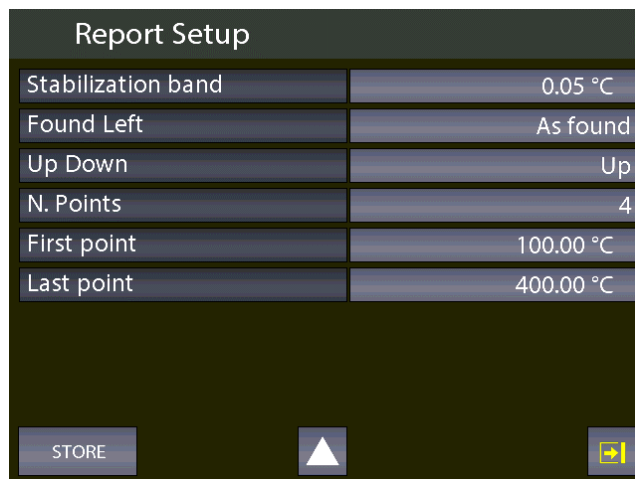
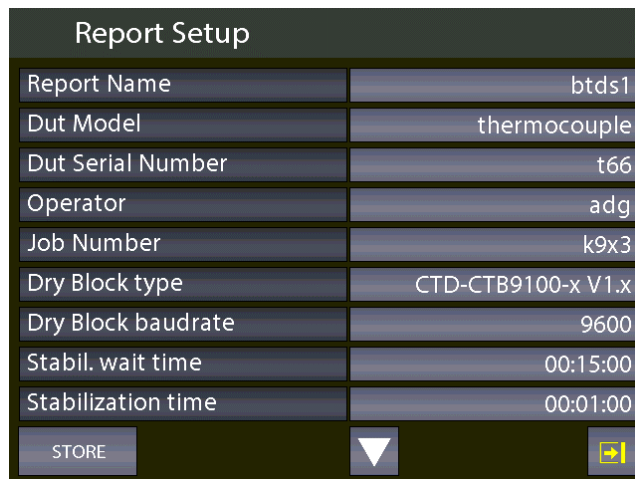

The following parameters have to be configured at first in order to create reports for Thermocouples/Thermoresistances:

“DST model”: set the type of thermometer by selecting “thermocouple” or “RTD. Do not leave the field as “not defined” otherwise the Pascal Report software will be not able to run the proper report type.

“Dry well type”: select the dry well calibrator connected to the Pascal calibrator

“Dry well Baud rate”: set the Baud rate value that must be the same used by the dry well calibrator.

**Note:** some dry well calibrators require the interface converter kit.

“Stab. Wait. Time”: set the stability waiting time in the hh:mm:ss format. The Pascal calibrator, after setting the temperature point for the report for the serial interface, will wait this dead time before starting to detect the temperature stability value.

“Stab. Time” and “Stab. Band”: the algorithm for detecting the stability value will consider the temperature stable by using the two set parameters. When the instrument will detects a stable temperature, the report will store the values of the thermometers and then will proceed to the next set point.

The “Stab. Band” parameter indicates the temperature range where the temperature value must not fall within for the set time. This allows to detect a stable temperature value.

The value describes above depend of the type of the connected dry well calibrator and its setting specifications.

Consider the following chart:

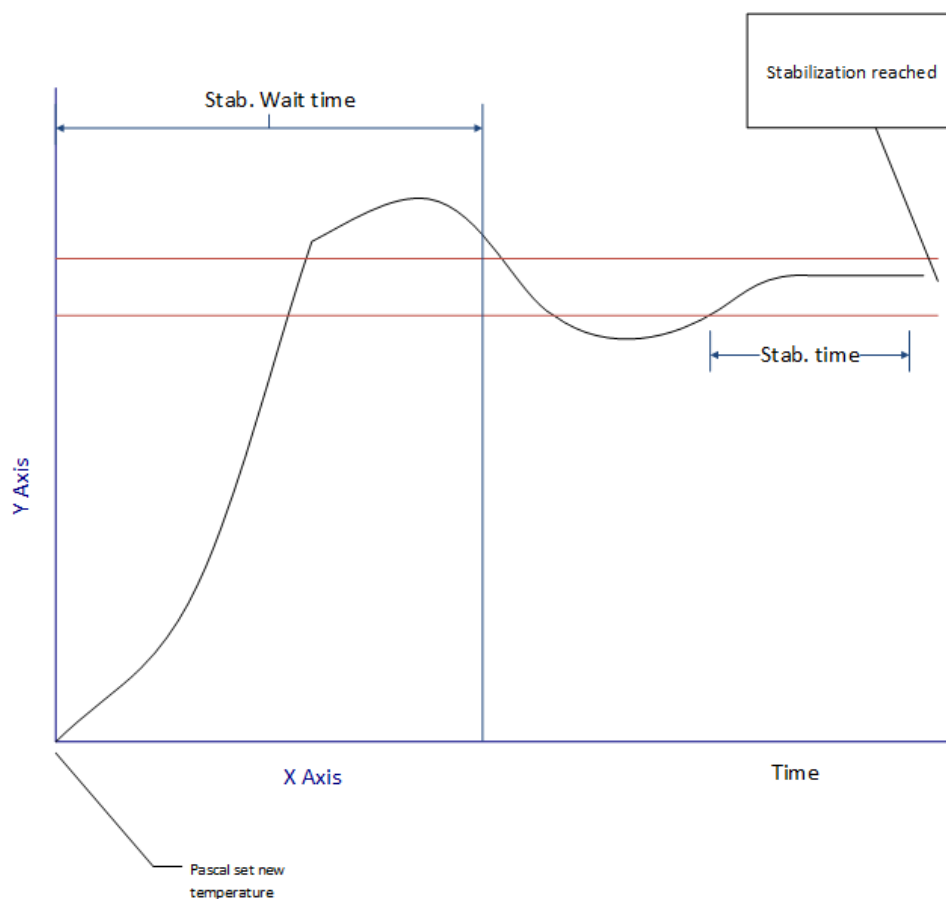

Run the report and the instrument display:



The display shows the status “Stab. Wait. Time” with the remaining time indication.

When the stabilization time is reached the instrument will enter the searching for stabilization:



The display show the parameter “Stabilization Time”: the value will come back to the starting value as soon as the temperature goes outside the set range. The counting will start again, starting from the new time counting, the instrument will check that the temperature value will not change over the set range.

The stability is reached when the timing reach the zero. Then, the instrument will store the REF and DST values and will start with the next point by repeating the previous steps for all the points set for the Report.

Importing the Report on a PC by using the Pascal Report Software:

The report can be imported on a PC when completed in order to be printed. The software will use the proper template based on the set “thermocouple” or “RTD” parameter:

GB

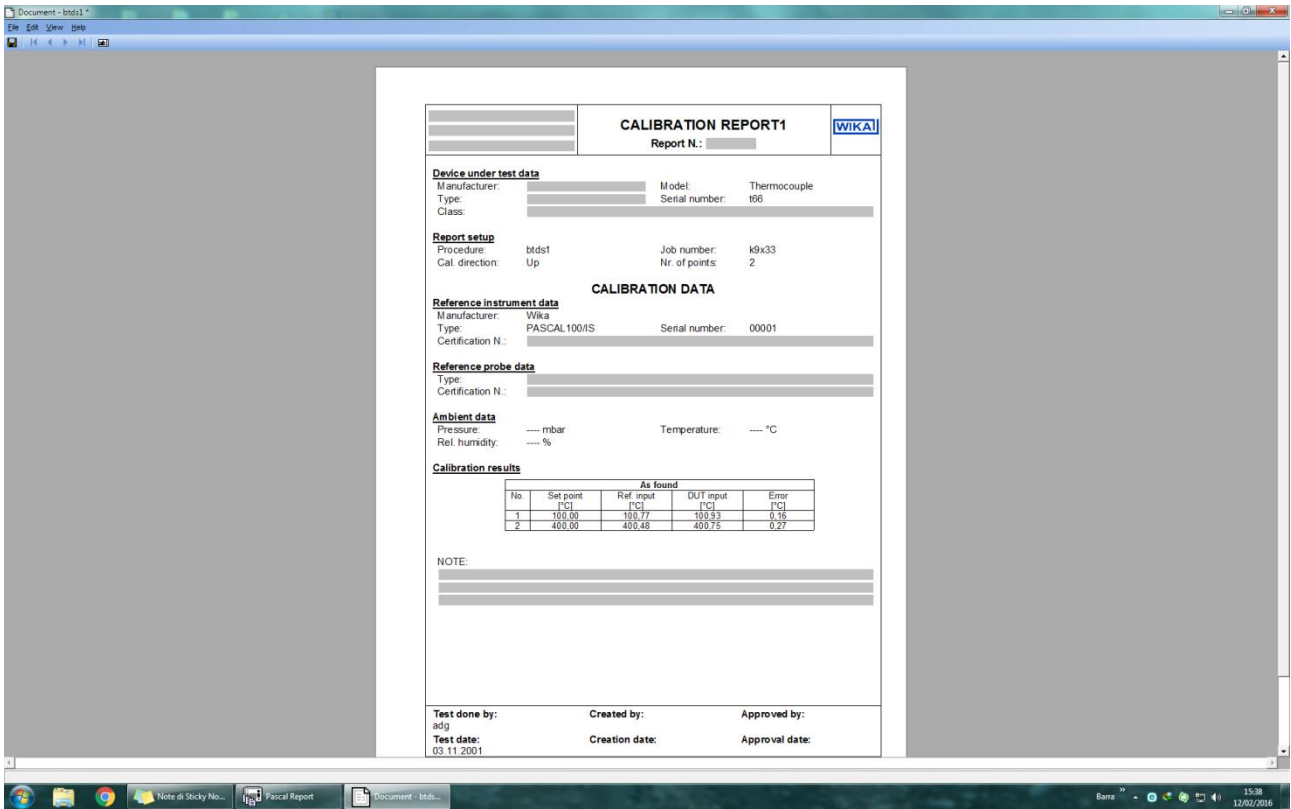

This template differs from the standard one in some freely settable fields as indicated below:

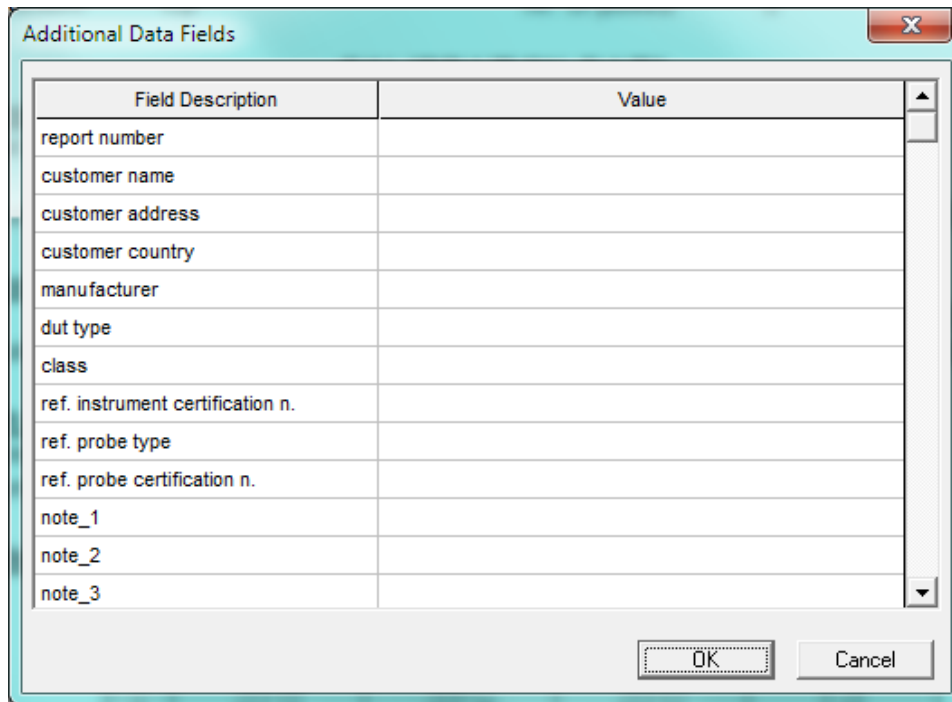

This template will also shows the errors in the set engineering unit and not in percentage.

## 6.7 Data Logger

Options are available on the screen for the Functions Setting (see paragraph 6.5.2.):

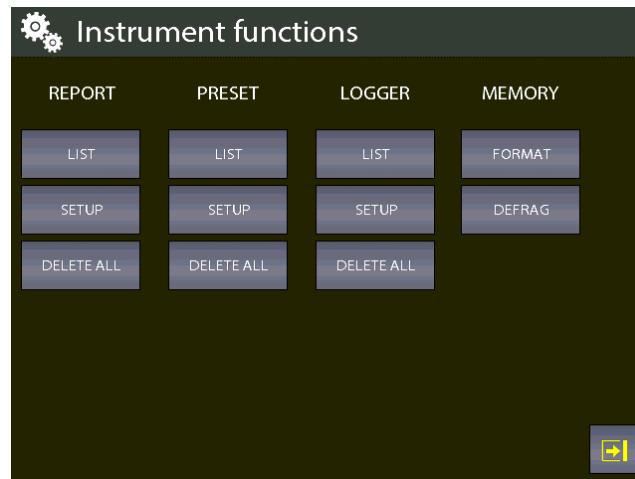

Figure 83 – Logger screen

On the LOGGER column, the following options are available:

- LIST** set up of the Logger
- SETUP** View Logs data
- DELETE ALL** delete all the Logs

With this function you can configure the data logger for all 4 channels simultaneously.

Selecting SETUP, "Data Logger Setup" will be displayed as per the below:

- Log Name Name of the Log (compulsory)
- Sampling time sampling time between 2 measurements (hours, min., sec.)
- Sampling length total time of the logging

Pressing START, the logging process will start:

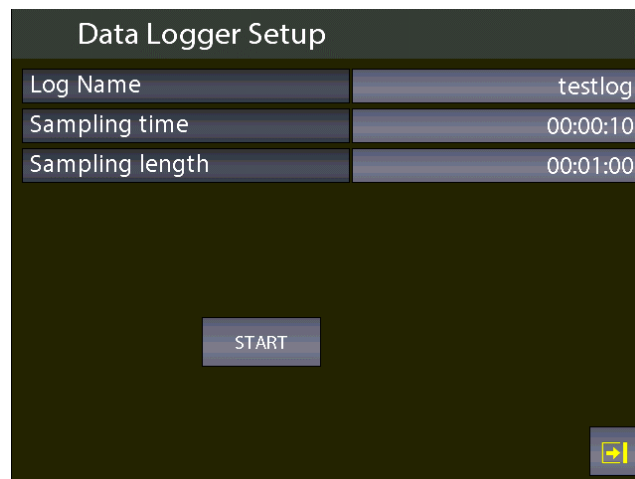

Figure 84 – Logger data setup

The flashing of the disc icon, on the bottom right side of the screen, shows that the LOGGER is active. The data will be stored on all 4 Channels (if assigned) simultaneously

GB



Figure 85 – Logger running

By pressing DELETE ALL on the LOGGER column on the screen of the Functions Setting, all the logs will be deleted: a confirmation will be asked to the user before proceeding.

Press the button LIST to show all the stored logs.



Figure 86 – Display Log list

Press the button with grey background next to the log name to see the data of each log. You can DELETE the selected log by pressing and keeping pressed the button with grey background next to the log name: a confirmation will be asked to the user before proceeding.

### 6.8 Communication

With the Software Program PascalReport, all reports can be downloaded to a PC. Through the Software Program PasLog, all logs can be downloaded to a PC.



Following configuration is required for the download of the data: press the button

Setup instrument	
Date	10/04/17
Time	12:01:18
Date format	dd/mm/yy
Language	english
Serial baudrate	460800
AutoPoweroff time	0 min
Lock scr. PowerON	OFF
F Key assign	Not assigned

Figure 87 – Display instrument setup

## 6.9 Calibration Examples

### 6.9.1 Example 1 – Calibration of 2-wire pressure transmitters

Pascal ET, ET-P, ET/IS, ET-P/IS generates 24 V d.c. power supply to the transmitter. The 4-20 mA output signal from the transmitter is sent to be measured to an electrical input signals card IN A or IN B.

The pressure reference value to the transmitter is generated by the hand pump and by the fine volumetric regulator, both present in the calibrator, and measured as REF by the calibrator itself. The figure below shows how to connect the transmitter to the calibrator.

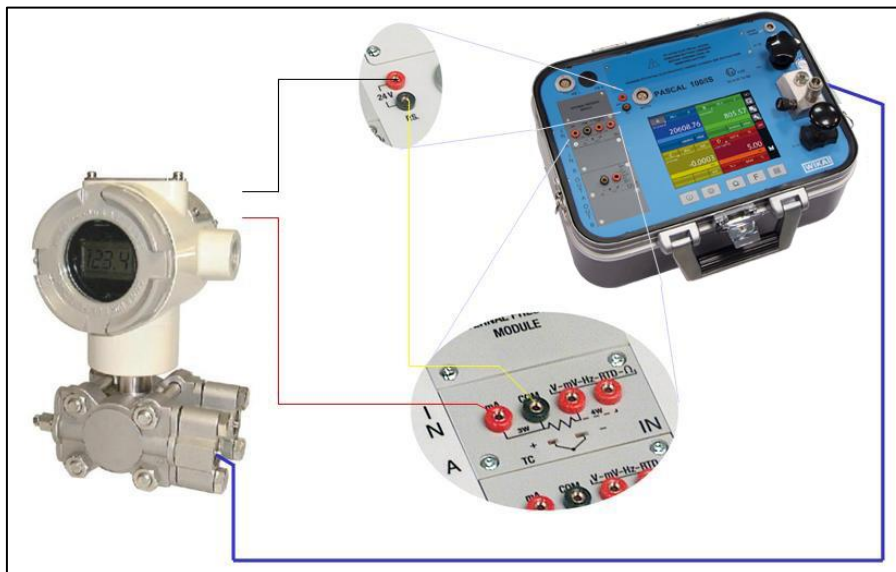



Figure 88 – Pressure transmitter calibration example

A typical configuration of Pascal100 for the calibration of a pressure transmitter is illustrated in the following figure:

- Set a channel for pressure values reading, assigned as REF
- Set a channel for mA reading at the inputs IN A or IN B (if present), assigned as DUT
- Enable the 24 V power supply by pressing the button  from the side bar
- Make the connections as indicated on the picture above

### 6.9.2 Example 2 – Calibration of PTZ gas volume converters

Pascal ET, ET-P, ET/IS, ET-P/IS can be used to calibrate a gas volume converter, where the absolute pressure, the temperature value and the Z factor are used to convert the gas volume measurement.

Gas volume, calculated at standard conditions.

The following figure shows the use of the calibrator.

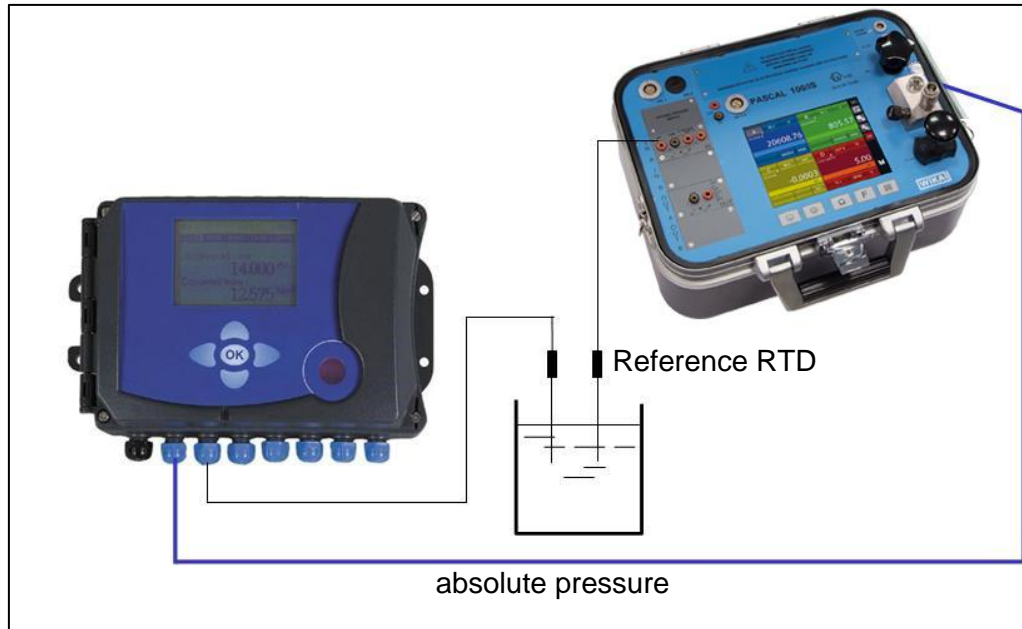

Figure 89 – PTZ Gas volume converter calibration example

### 6.9.3 Example 3 – Calibration of 4-wire RTD's

A 4-wire RTD can be calibrated by using the method of comparison, connecting it to the input (IN A) as a DUT (Device Under Test) and comparing it with a reference RTD connected to the other input (IN B) as REF (Reference),

In this way the two measures can be compared, the calculated error is reported on the calibration report.

The figure below shows the connection of the calibrator



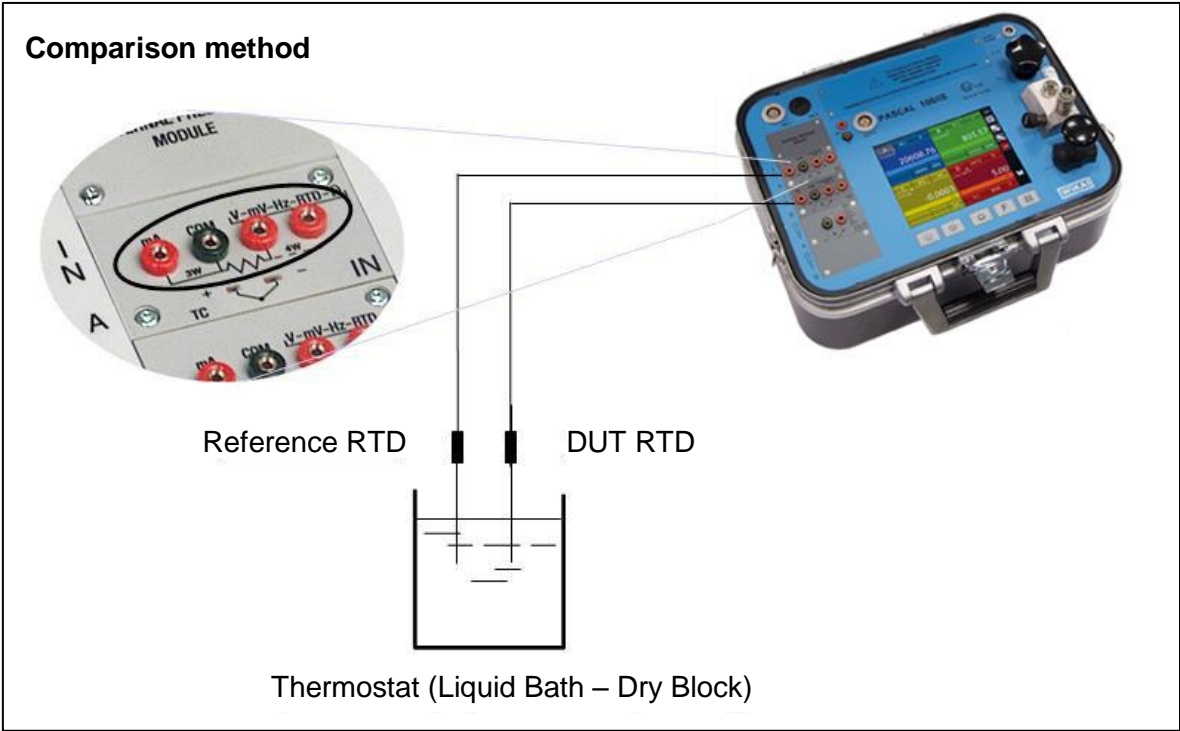

Figure 90 – 4-wire thermoresistance calibration example

#### 6.9.4 Example 4 – Calibration of Thermocouples

The calibration of thermocouples is similar to that of RTDs, i.e. by comparison, except for the choice of the type of reference thermocouple to be used accordingly to the types of thermocouples to be calibrated.

GB

You must also select the cold junction compensation if the internal, external or assigning a compensation value.

The figure below shows the connection of the calibrator:

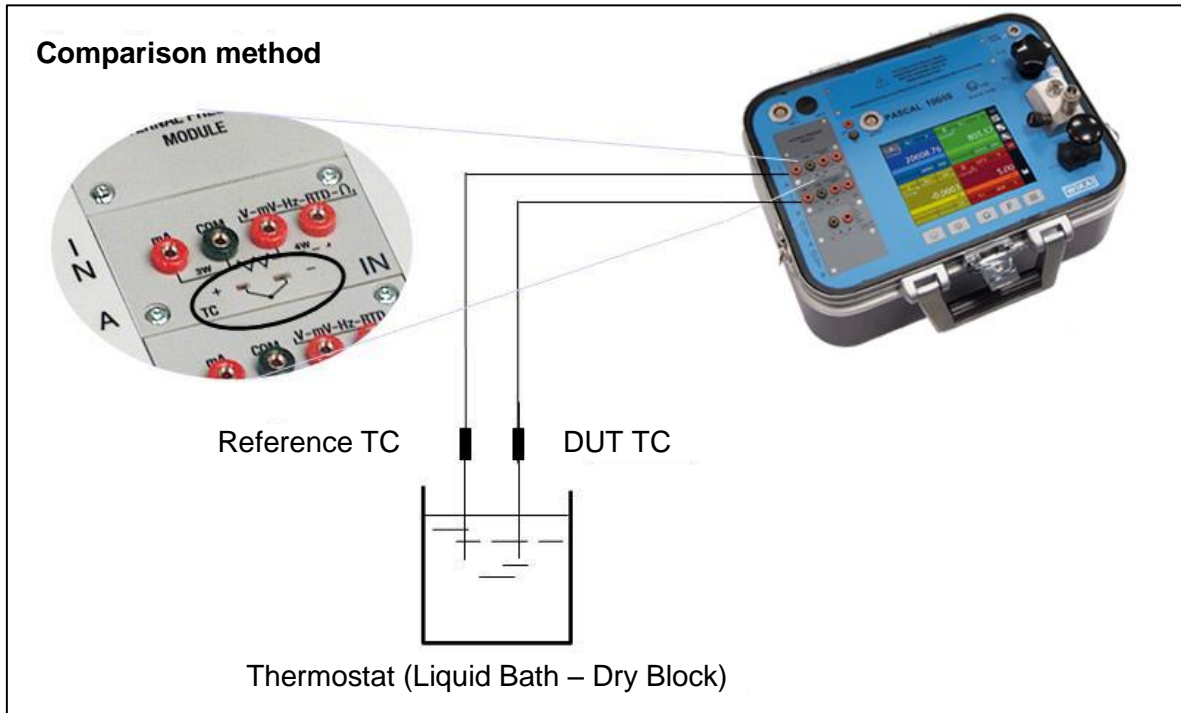

Figure 91 – Thermocouple calibration example

## 7 Maintenance, cleaning and servicing

### 7.1 Maintenance

The Multichannel Calibrator model Pascal ET, ET-P, ET/IS, ET-P/IS is maintenance-free. Repairs must only be carried out by the manufacturer.

GB

### 7.2 Cleaning

**CAUTION!**

- Before cleaning, correctly disconnect the Multichannel Calibrator model Pascal ET or Pascal ET/IS from the pressure supply, and switch it off.
- Clean the Multichannel Calibrator model Pascal ET, ET-P, ET/IS, ET-P/IS with a moist cloth.
- Electrical connections must not come into contact with moisture.



For information on returning the instrument see chapter "8.2 Return"

### 7.3 Recalibration

**DKD certificate - Certificates:**

We recommend that the instrument is regularly recalibrated by the manufacturer, with time intervals of approx. 12 months. Every factory recalibration includes, additionally, an extensive free-of-charge check of all system parameters with respect to their compliance with the specification. The basic settings will be corrected if necessary.

## 8 Dismounting, return and disposal

GB



### **WARNING!**

Residual media in dismantled reference pressure sensors can result in a risk to persons, the environment and equipment.  
Take sufficient precautionary measures.

### 8.1 Dismounting

Only disconnect test- and calibration installations once the system has been depressurised!

### 8.2 Return



### **WARNING!**

#### **Strictly observe when shipping the instrument:**

All instruments delivered to WIKA must be free from any kind of hazardous substances (acids, bases, solutions, etc.).

When returning the instrument, use the original packaging or a suitable transport package.

#### **To avoid damage:**

1. Wrap the instrument in an antistatic plastic film.
2. Place the instrument, along with the shock-absorbent material, in the packaging. Place shock-absorbent material evenly on all sides of the shipping box.
3. If possible, place a bag, containing a desiccant, inside the packaging.
4. Label the shipment as transport of a highly sensitive measuring instrument.

Enclose the completed return form with the Multichannel Calibrator model Pascal ET or Pascal ET/IS.



The return form is available on the internet:  
**[www.wika.it](http://www.wika.it) / Servizi / Productreturn**

### 8.3 Disposal

Incorrect disposal can put the environment at risk.

Dispose of instrument components and packaging materials in an environmentally compatible way and in accordance with the country-specific waste disposal regulations.